

Im Hofstätt 11
D-72359 Dotternhausen
Phone +49 (0)7427 9480-0
Fax +49 (0)7427 9480-7025
e-mail info@proactiv-gmbh.de
www.proactiv-gmbh.com



TRAVELER 4all Ergo Active easy running folding wheelchair

Maximum user weight limit 120 kg

A9035100000 € 4,270.00

Quotation date: _____

**Consultation was carried out by
Staff at the medical supplies shop:** _____

PRO ACTIV field representative: _____

Order date: _____

according to GTC PRO ACTIV GmbH

Medical suppliers/company address:

Cust. no.: _____
Name: _____
Street: _____
Postcode / city: _____
Phone: _____
Fax: _____
E-Mail: _____
Contact: _____

Invoicing address: **same as company address**

other (see below)

Cust. no.: _____
Name: _____
Street: _____
Postcode / city: _____
Phone: _____
Fax: _____
E-Mail: _____
Contact: _____

Shipping address: **same as company
address**

Other (see below)

Name: _____
Street: _____
Postcode / city: _____

Customer name/commission:

Surname, _____
forename: _____
Street: _____
Postcode / city: _____
Phone: _____
Fax: _____
E-Mail: _____
D.O.B: _____
Paying _____
organisation: _____

Basic size

Body size:

Body height: _____ cm

Weight: _____ kg

Lower leg length: _____ cm
(anatomic dimension: hollow of the knee to the foot sole):

Indication: _____

This information is mandatory for further processing.

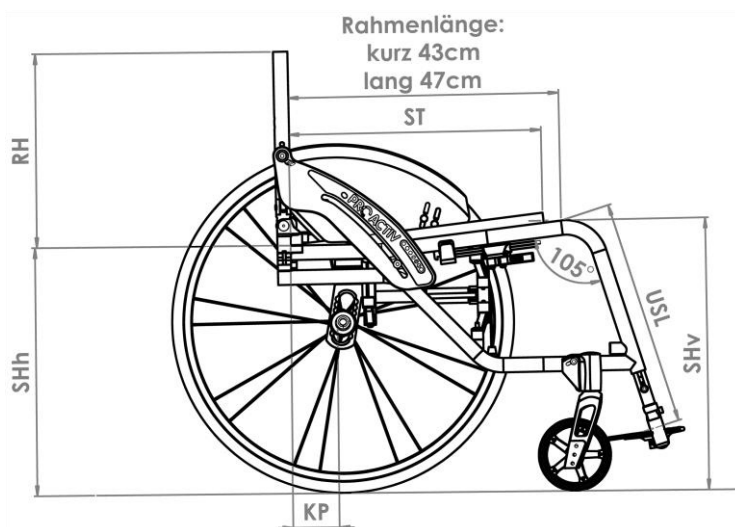
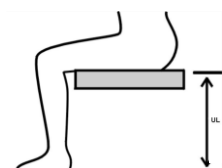

Wheelchair dimensions:

Seat width SB	<input type="checkbox"/> 33	<input type="checkbox"/> 34	<input type="checkbox"/> 35	<input type="checkbox"/> 36	<input type="checkbox"/> 37	<input type="checkbox"/> 38	<input type="checkbox"/> 39	<input type="checkbox"/> 40	Optional with frame, long, special dimension SB possible:			
	<input type="checkbox"/> 41	<input type="checkbox"/> 42	<input type="checkbox"/> 43	<input type="checkbox"/> 44	<input type="checkbox"/> 45	<input type="checkbox"/> 46	<input type="checkbox"/> 47	<input type="checkbox"/> 48	<input type="checkbox"/> 49	<input type="checkbox"/> 50	<input type="checkbox"/> 51	<input type="checkbox"/> 52
Seat depth ST	Short frame					Long frame						
	<input type="checkbox"/> 36	<input type="checkbox"/> 37	<input type="checkbox"/> 38	<input type="checkbox"/> 39	<input type="checkbox"/> 40	<input type="checkbox"/> 40	<input type="checkbox"/> 41	<input type="checkbox"/> 42	<input type="checkbox"/> 43	<input type="checkbox"/> 44		
Back height RH	<input type="checkbox"/> 20	<input type="checkbox"/> 21	<input type="checkbox"/> 22	<input type="checkbox"/> 23	<input type="checkbox"/> 24	<input type="checkbox"/> 25	<input type="checkbox"/> 26	<input type="checkbox"/> 27	<input type="checkbox"/> 28	<input type="checkbox"/> 29		
	<input type="checkbox"/> 30	<input type="checkbox"/> 31	<input type="checkbox"/> 32	<input type="checkbox"/> 33	<input type="checkbox"/> 34	<input type="checkbox"/> 35	<input type="checkbox"/> 36	<input type="checkbox"/> 37	<input type="checkbox"/> 38	<input type="checkbox"/> 39		
	<input type="checkbox"/> 40	<input type="checkbox"/> 41	<input type="checkbox"/> 42	<input type="checkbox"/> 43	<input type="checkbox"/> 44	<input type="checkbox"/> 45	<input type="checkbox"/> 46	<input type="checkbox"/> 47	<input type="checkbox"/> 48			
Lower leg length USL	<input type="checkbox"/> 37	<input type="checkbox"/> 38	<input type="checkbox"/> 39	<input type="checkbox"/> 40	<input type="checkbox"/> 41	<input type="checkbox"/> 42	<input type="checkbox"/> 43	<input type="checkbox"/> 44				
	<input type="checkbox"/> 45	<input type="checkbox"/> 46	<input type="checkbox"/> 47	<input type="checkbox"/> 48	<input type="checkbox"/> 49	<input type="checkbox"/> 50	<input type="checkbox"/> 51					
Seat height back SHh (for 24" drive wheels)	<input type="checkbox"/> 39	<input type="checkbox"/> 40	<input type="checkbox"/> 41	<input type="checkbox"/> 42	<input checked="" type="checkbox"/> 43	<input type="checkbox"/> 44	<input type="checkbox"/> 45					
Seat height front SHv	<input type="checkbox"/> 44	<input type="checkbox"/> 45	<input type="checkbox"/> 46	<input checked="" type="checkbox"/> 47	<input type="checkbox"/> 48	<input type="checkbox"/> 49	<input type="checkbox"/> 50	<input type="checkbox"/> 51	<input type="checkbox"/> 52			
Tipping point KP (Front of back tube up to axis middle drive wheel)	<input type="checkbox"/> 3	<input type="checkbox"/> 4	<input type="checkbox"/> 5	<input type="checkbox"/> 6	<input type="checkbox"/> 7	<input checked="" type="checkbox"/> 8	<input type="checkbox"/> 9	<input type="checkbox"/> 10	<input type="checkbox"/> 11			

Please cross on the appropriate dimension (all dimensions are specified in cm).

Underlined values are standard settings.

The values SHh and SHv may deviate a little from the specified values depending on the wheel size, wheel camber as well as the front and rear frame angle!

Special dimensions possible upon request.

Frame colour – one-colour design

Information about current colour designs and example images at: www.proactiv-gmbh.de/farben.php

frame colour: Selection from colour palette

Frame colour is specified when ordering

A9000100170-000

Powder coatings

White RAL 9016

gloss A9000100170-023

matt A9000100170-123

€ 40.10

Brilliant silver

gloss A9000100170-011

Anthracite RAL 7016

gloss A9000100170-001

matt A9000100170-101

€ 40.10

Black RAL 9005

gloss A9000100170-003

matt A9000100170-019

€ 40.10

Pure orange RAL 2004

gloss A9000100170-022

matt A9000100170-122

€ 40.10

Pink magenta RAL 4010

gloss A9000100170-037

matt A9000100170-137

€ 40.10

Pastel blue RAL 5024

gloss A9000100170-036

matt A9000100170-136

€ 40.10

Lemon green

gloss A9000100170-005

matt A9000100170-105

€ 40.10

Yellow RAL 1023

gloss A9000100170-046

matt A9000100170-146

€ 40.10

Red RAL 3001

gloss A9000100170-047

matt A9000100170-147

€ 40.10

Lagoon blue

gloss A9000100170-052

matt A9000100170-152

€ 40.10

Athletic grey

gloss A9000100170-050

matt A9000100170-150

€ 40.10

Muddy grey

gloss A9000100170-051

matt A9000100170-151

€ 40.10

“Dormant” powder coatings

Deep black, silver effect

gloss A9000100170-007

Sky blue

gloss A9000100170-017

Marine blue

gloss A9000100170-045

matt A9000100170-145

€ 40.10

Electric green

gloss A9000100170-015

matt A9000100170-115

€ 40.10

Violet

gloss A9000100170-044

Fire red

gloss A9000100170-018

matt A9000100170-118

€ 40.10

Frame colour – “liquid coating” one-colour design

€ 323.20

Storm (ice blue)

gloss A9000100170-500

matt A9000100170-501

Coffee

gloss A9000100170-520

matt A9000100170-521

Prairie (rose gold)

gloss A9000100170-504

matt A9000100170-505

Pearl (mother of pearl-white)

gloss A9000100170-524

matt A9000100170-525

Berry

gloss A9000100170-526

matt A9000100170-527

Blue ocean

gloss A9000100170-522

matt A9000100170-523

Emerald (emerald green)

gloss A9000100170-514

matt A9000100170-515

Mint

gloss A9000100170-528

matt A9000100170-529

Chilli

gloss A9000100170-516

matt A9000100170-517

Frame colour – two colour designs

Note: Frames with two colour designs in the gloss level of the design colour.

Two-colour design comprising one basic colour (on the back of the frame) and one design colour (on the front of the frame) € 248.30

Please select from the following colours:

Base colour (on the rear frame)

White RAL 9016

A9000100170-200

Brilliant silver

A9000100170-201

Anthracite RAL 7016

A9000100170-202

Black RAL 9005

A9000100170-203

Pastel blue RAL 5024

A9000100170-206

Lemon green

A9000100170-207

Yellow RAL 1023

A9000100170-208

Lagoon blue

A9000100170-212

Athletic grey

A9000100170-210

Muddy grey

A9000100170-211

Design colour (on the front frame)

Black RAL 9005

gloss A9000100170-259

matt A9000100170-260

Lemon green

gloss A9000100170-250

matt A9000100170-251

Chilli

gloss A9000100170-253

matt A9000100170-254

Pure orange RAL 2004

gloss A9000100170-255

matt A9000100170-256

Coffee

gloss A9000100170-278

matt A9000100170-279

Mint

gloss A9000100170-286

matt A9000100170-287

Emerald (emerald green)

gloss A9000100170-274

matt A9000100170-275

Storm (ice blue)

gloss A9000100170-264

matt A9000100170-265

Prairie (rose gold)

gloss A9000100170-266

matt A9000100170-267

Pearl (mother of pearl-white)

gloss A9000100170-282

matt A9000100170-283

Berry

gloss A9000100170-284

matt A9000100170-285

Blue ocean

gloss A9000100170-280

matt A9000100170-281

Colour - Attachment parts

Note: If no specifications have been made, the caster fork and bearing block are mounted in black.

Drive wheel: Aluminium rim, hub and spokes

Black A9000100171-003

Caster fork and bearing block

Silver A9000100173-011

Black A9000100173-003

Attachment parts colour design according to customer desires:

Drive wheel: Aluminium rim and design inlet¹

Pure orange RAL 2004 A9000100171-022 € 193.10

White RAL 9016 A9000100171-023 € 193.10

Frame colour A9000100171-999 € 230.80

Selection of single colour coating (deviating from the frame colour) A9000100171-998 € 267.10

Colour: _____

A9000100170-

Caster wheel: 5" aluminium rim² (3-spoke design)

Pure orange RAL 2004 A9000100174-022 € 44.40

White RAL 9016 A9000100174-023 € 44.40

Frame colour A9000100174-999 € 69.50

Selection of single colour coating (deviating from the frame colour) A9000100174-998 € 80.60

Colour: _____

A9000100170-

Special colour requests (frame or attachment parts)

Frame colour individual procurement Selection from RAL colour palette

A9000100170-100 € 383.10

Degree of gloss

gloss

matt

Colour designation

RAL number

Note: Attachment parts **not** possible in design colours

¹ Only in conjunction with Liteline hub (for drive wheel aluminium rim with 18 or 36 spokes, object).

² Only in conjunction with 5" caster wheel aluminium rim 3-spoke design easy running A9000501200 or good shock absorption A9000501210

Frames

Note: Footrest area with V-shape $x=SB - (0.25 \times USL + 6 \text{ cm})$

Straight front end

A9035100012-K*
Knee angle 95°

A9035100010-K*
Knee angle 105°



Front end V-shape

A9035100020-K* € 280.80
Knee angle 95°

A9035100023-K* € 280.80
Knee angle 105°

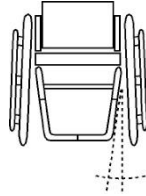

Custom-made seat width 49 cm - 52 cm

A9030100060 € 282.90

Push handles

Back tube with integrated handles

A9000401051-K € 120.60
straight

Also possible with lumbar curvature:

1 cm

2 cm

3 cm



Aluminium push handles fixed mounted in the back tube

A9000401050 € 120.60
from RH 23 cm



Horizontal push handles screwed into the back tube

A9000401076 € 223.60
can be unscrewed



Safety push handles with continuous height adjustment

A9000401060 € 200.10

Mount in the back tube
from RH 30 cm with adaptable back
from RH 43 cm with back shell
Starting at a back height of 35 cm for back
tube with lordosis support



Safety push handles back-positioned length 45 cm

A9030401071 € 377.50

continuous height adjustment,
Safety push handle holder mounted on the
back cross bar
Up to seat width of 42 cm or body weight of
95 kg
Cannot be swivelled in conjunction with
armrest



Backrest

Folding backrest

A9000400021
7-way inclination adjustment
with integrated plastic coated
Aluminium side sections



Back tube with lumbar curvature

A9000400005-K € 105.80

1 cm

2 cm

3 cm



Back equipment

Adaptable back with back padding

A9000802010-K
Cover: Black, breathable, open surface
Cushion thickness: 16 mm
Equipment with back cross bar



Adaptable back with "Light" back padding

A9000802320-K € 42.80
Back padding with extra thin padding for easy, space-saving folding of the wheelchair.
Cover fabric: Black, breathable, open surface
Cushion thickness: 9 mm
Equipment with back cross bar
Note: Not recommended if there is a risk of pressure marks on the back.

Raised back + 3 - 5 cm

A9000802100 € 144.40
for nominal RH dimension
Only in combination with height adjustable push handles



Equipment without back upholstery and back padding or back system

A9000802011 € -53.00
Equipment with back cross bar

Other back systems, such as ergonomic back shell etc. see separate order sheet: "PRO ACTIV seat and back systems"



You will find our PRO ACTIV transport restraint systems on our separate "Transport restraint systems" order sheet



Seat upholstery

Open belt system

A9000801011-K

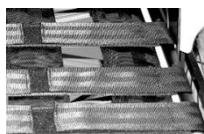

Closed belt system

A9000801020-K € 85.40



Equipment without seat upholstery

A9000801050



Seat cushion

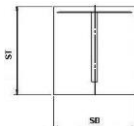

Seat cushion in rectangular contour Inlet: Standard

A9000805180-K* € 106.60

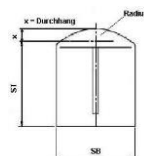

Seat cushion with radius contour Inlet: Standard

A9000800300-K* € 148.00

Seat cushion height:

3 cm 5 cm
 4 cm 6 cm

Seat cushion in rectangular contour Inlet: Anti-Decubitus

up to 30x30 cm
A9000805204-K* € 276.20

>30x30 up to
50x50 cm
A9000805200-K* € 401.90

Seat cushion with radius contour Inlet: Anti-Decubitus

up to 30x30 cm
A9000800311-K* € 326.50

>30x30 up to
50x50 cm
A9000800310-K* € 443.70

Seat cushion height:

4 cm
 6 cm

Cover: Black, breathable, open surface Black, breathable, closed surface

If not specified, the cover fabric "black, breathable, open surface" is delivered.

 Seat cushion is existing

Brand/type _____

Cushion height _____ cm

You can also find the seat cushions on our separate "PRO ACTIV Seat and Back Systems" order sheet**Clothing guard****Aluminium clothing guard removable via lock function**

Adjustable following wheel arch

Only in combination with folding backrest

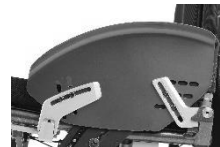

in anthracite matt

 A9000403215-K € 224.90

in frame colour (basic colour with two-colour design)

 A9000403216-K € 287.60

in design colour (only possible with frame colour in two-colour design)

 A9000403217-K € 319.40**Carbon clothing guard removable via lock function** A9000400013-K € 521.20

Adjustable following wheel arch

Only in combination with folding backrest

**Armrests****Armrest, height adjustable, integrated in the clothing guard**

Including aluminium clothing guard

with arm padding 25 cm long

Removable via lock function

Only in combination with folding backrest



in anthracite matt

 A9000400014-K € 526.70

in frame colour (basic colour with two-colour design)

 A9000400015-K € 575.00

in design colour (only with frame colour in two-colour design)

 A9000400016-K € 599.20**Armrest, height adjustable, integrated in the clothing guard** A9000400017-K € 797.00

Including carbon clothing guard

with arm padding 25 cm long

Removable via lock function

Only in combination with folding backrest

Axle plate

Standard equipment with 12 mm sockets/axle.

Wheelbase extension via "grid mechanism with pulling operation" A9110102001 € 537.50

removable, with continuous axle tube, 4°/6° camber integrated, independently adjustable track



Wheel camber

*Total width with tight-mounted handrim

1° drive wheel camber

A9030202010
Total width = approx. SB + 20 cm*

4° drive wheel camber

A9030202030
Total width = approx. SB + 26 cm*

6° drive wheel camber

A9030202040
Total width = approx. SB + 30 cm*

E-adaptations

Preparation for "e-motion" mounting

A9030201200* € 465.00
Equipment: e-motion torque support, 1/2" axle and socket length 50.8 mm (2")
PRO ACTIV and Alber recommend anti-tipping supports are installed in pairs. Please select under "Adaptations".

Preparation for "e-fix" mounting

A9030201210* € 465.00
Equipment: e-fix torque support, 1/2" axle and socket length 50.8 mm (2")
PRO ACTIV and Alber recommend anti-tipping supports are installed in pairs. Please select under "Adaptations".

Wheelchair delivery to

Alber GmbH
(Please also enter on p.1 under "Shipping address, other")
 Specialist dealer

Brake system

Integrated parking brake

A9035705000 € 229.80
Brake lever fixed under the upper frame tube
Only in combination with 4° drive wheel camber.



Brake system push to lock Standard brake handle

A9000701010-001



Brake system push to lock Long brake lever

A9000701010-002



Brake system push to lock Low brake handle

A9000701010-003



Brake lever at 20°

A9000700002
Only in conjunction with knee lever brake system, standard brake lever, long or low.



Brake system push to lock Brake handle to flip-down

A9000706008 € 146.70
Length: 9 cm

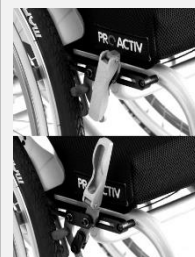

Footrest

Continuous footrest

A9030601000-K
with tubular resting bracket, foldable, removable
When folding the wheelchair, the footrest also folds completely from USL 37 cm.
With foot support area $x < 22$ cm the foot bracket is designed to be parallel.
For equipment of the footrest with "Rubber coated footplate support", please select under "Footrest accessories"



Footrest folding up to one side









A9030601300-K* € 228.70
with continuous tubular resting bracket, height adjustable +/- 3 cm, can be pivoted outwards, removable (with V-shape from SB 40 cm)
For equipment of the footrest with "Rubber coated footplate support", please select under "Footrest accessories"



Footbar folds up to the rear with spring locking mechanism

A9035602005-K* € 326.60
removable, with continuous tubular resting bracket
for KW 105° from USL 39 cm
for KW 95° from USL 38 cm
For equipment of the footrest with "Rubber coated footplate support", please select under "Footrest accessories"



<p>Divided footrest</p> <p><input type="checkbox"/> A9030603101-K € 374.20</p> <p>with rubber coated footplate, angle-adjustable, can be pivoted outwards and folded up to the side, removable with V-shape from SB 40 cm</p> 	<p>“Swing away” footrest</p> <p><input type="checkbox"/> A9016604100-K € 374.20</p> <p>with rubber coated footplate, separated in the middle, pivoted to the side, can be folded up, height adjustable, removable, angle-adjustable</p> 	
Footrest accessories		
<p>Rubber coated footplate</p> <p><input type="checkbox"/> A9000610000-K € 116.40</p> <p>bolted, angle-adjustable Depth: 14 cm</p> 	<p>Footplate side stop</p> <p><input type="checkbox"/> A9000610100 € 55.20</p> <p>adjustable only in combination with rubber coated footplate</p> 	
Adaptations		
<p>Anti-tipping support</p> <p><input type="checkbox"/> right side € 156.40 A9000300100-K001</p> <p><input type="checkbox"/> left side € 156.40 A9000300100-K002</p> <p>adjustable, removable, can be pivoted, with tension spring and universal adapter</p> 	<p>Preparation for mounting the anti-tipping support with lifting function from Alber (e-fix, e-motion)</p> <p><input type="checkbox"/> A9016300105 € 274.40</p> <p>Universal adapter is prepared for mounting the anti-tipping support with lifting function from Alber. Supplied without anti-tipping support and anti-tipping support mount. On the customer side, please order this from Alber</p> 	<p>Transit wheels</p> <p><input type="checkbox"/> A9000301100 € 304.80</p> <p>detachable with universal adapter Not in combination with anti-tipping support</p> 
<p>Tilting clamp</p> <p><input type="checkbox"/> right side € 129.50 A9000302100-001</p> <p><input type="checkbox"/> left side € 129.50 A9000302100-002</p> <p>with universal adapter and Quick pin Not in combination with anti-tipping support, right side or left side</p> 		

3" caster wheel

3" Skate wheel (80 mm)

A9000501110 € 65.40
puncture-proof



4" caster wheel

4" caster wheel "Standard" solid rubber black

A9000501011-004
(82A), puncture-proof



4" Skate wheel (100 mm)

A9000501120 € 65.40
puncture-proof



4" safety light-up wheel (100 mm)

A9000501220 € 87.60
puncture-proof



4" Frog Legs caster wheel (100 mm)

A9000501230 € 196.50
with replaceable rubber 6 mm, puncture-proof
Colour: black, silver rim
Incl. hair guard spacer (5.3 mm)



5" caster wheel

5" caster wheel "Standard" PU black

A9000501036-005
(82A), puncture-proof



5" Caster wheel "Standard" PU grey

A9000501031-005
(82A), puncture-proof



5" Caster wheel "2 components"

A9000501030 € 52.00
puncture-proof



5" safety light-up wheel (125 mm)

A9000501221 € 87.60
puncture-proof



5" Aluminium rim 3-spoke design "easy running"

Silver, anodised
A9000501200 € 160.50

black
A9000501201 € 160.50

With exchangeable rubber ring 3 mm
hard, puncture-proof
Incl. hair guard spacer (3 mm)



5" aluminium rim 3-spoke design "Good shock absorption"

Silver, anodised
A9000501210 € 166.30

black
A9000501211 € 166.30

with replaceable rubber 6 mm medium hard,
puncture-proof
Incl. hair guard spacer (3 mm)



5" Frog Legs caster wheel (125 mm)

A9000501232 € 196.50

with replaceable rubber 6 mm, puncture-proof
Colour: black, silver rim
Incl. hair guard spacer (5.3 mm)



6" caster wheel

6" Caster wheel "Standard" PU grey

A9000501010-006
(82A), puncture-proof



6" caster wheel "pneumatic tyre"

A9000501050 € 52.90
SH front min. 42 cm



6" caster wheel "Flexel System"

A9000501070 € 52.90
puncture-proof



Caster fork

Caster fork colours, see "Component colours"

Caster fork Standard

A9000500100-K001
with screwed axle

A9000500100-K002 € 154.80
with quick-release axle



Heavy duty caster fork

For high loads or
when using additional electric drives

A9000510111-K001 € 49.90
with screwed axle

A9000510111-K002 € 202.40
with quick-release axle



Suspension fork

incl. 5" aluminium rim "good shock absorption"

A9000500160-K001 € 466.90
with screwed axle

A9000500160-K002 € 570.40
with quick-release axle



Caster fork spare wheel "Standard"

A9000500300-K € 274.40
Standard caster forks with quick-release axles



Caster fork spare wheel "Heavy Duty"

A9000500301-K € 312.50
Heavy duty caster forks with quick-release
axles



The spare caster fork does not have a caster
wheel.
In case a caster wheel is requested, please
put a cross on a second selection in the
category "Caster wheels".

Track distance

Caster wheel track extension



A9000500400* € 54.70
10 mm per side

A9000500401* € 54.70
15 mm per side

A9000500410* € 54.70
20 mm per side

Drive wheels

Information on further rim types, versions and availabilities under: www.proactiv-gmbh.de

Drive wheel, 18 spoke aluminium rim

- 24" (ETRTO 540)
A9000203122

with Liteline hub, spoked radially
Not in combination with:

- Puncture-proof tyres
- One-hand drive
- Adaptive bike

only up to a body weight of 70 kg:

Sturz \ Gewicht	1°	4°	6°	8°	10°
bis 50 Kg	✓	✓	✓	✓	✓
51 - 60 Kg	✓	✓	✓	✓	
61 - 70 Kg	✓	✓			



Drive wheel, 36 spoke aluminium rim

- 24" (ETRTO 540)
A9000203000

Up to 120 kg body weight with Liteline hub
(left image)

Over 120 kg body weight with aluminium high
flange (right image)
radially spoked



Drive wheel double rim 36 spokes

- 24" (ETRTO 540)
A9000203100 € 145.90

- 25" (ETRTO 559)
A9000203200 € 145.90

- 26" (ETRTO 590)
A9000203300 € 145.90

with aluminium front hub,
radially spoked

Use with higher loads and body weight > 120
kg



Spinergy running wheel "Spox Sport" with 24 PBO spokes; rim, hub and spokes in black

- 24" (ETRTO 540)
A9000203550 € 725.00

- 25" (ETRTO 559)
A9000201559 € 725.00

- 26" (ETRTO 590)
A9000203555 € 725.00



Spinergy "Everyday Light Extreme" with 12 PBO spokes; rim and hub in black, spokes white

- 24" (ETRTO 540)
A9000203554 € 885.00



Spinergy "Everyday Light Extreme" with 12 PBO spokes; rim, hub and spokes in black

- 24" (ETRTO 540)
A9000203552 € 885.00



Handrims

x = dimension handrim attachment

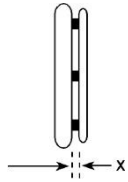

Handrim attachment
General:

- x = 11 mm
- x = 19 mm

Handrim attachment
Curve handrim:

- x = 10 mm
- x = 18 mm

Unless otherwise specified, the handrim is mounted wide (19 mm / 18 mm)

Stainless steel Ø 20 mm

- 24" handrim for 24" wheel and 25" wheel
A9000205010-004
- 26" handrim for 26" wheel
A9000205010-006



Aluminium Ø 19 mm silver anodised

- 24" handrim for 24" wheel and 25" wheel
A9000205019-004



Aluminium Ø 19 mm powder coated in frame colour

(basic colour with two-colour design)

- = Gloss surface
- = Matt surface

Note: Matt coating is not recommended due to the low grip.

- 24" handrim for 24" wheel and 25" wheel € 63.10
A9000205020-004
- 26" handrim for 26" wheel € 63.10
A9000205020-006



Aluminium Ø 19 mm polished and hard-anodised

- 24" handrim for 24" wheel and 25" wheel € 152.50
A9000205030-004
- 26" handrim for 26" wheel € 152.50
A9000205030-006



Titanium Ø 19 mm

- 24" handrim for 24" wheel and 25" wheel € 310.30
A9000205040-004
- 26" handrim for 26" wheel € 310.30
A9000205040-006



Silicone handrim cover

- for 24" handrim € 215.20
A9000205100-004
 - for 26" handrim € 215.20
A9000205100-006
- Surface without structure, compatible with handrim Ø 19 mm or Ø 20 mm.



Ultra-Grip "very grippy"

- 24" handrim for 24" wheel and 25" wheel € 372.10
A9000205070-004
- 26" handrim for 26" wheel € 372.10
A9000205070-006



Ergo-Grip

- 24" handrim for 24" wheel and 25" wheel € 377.90
A9000205080-004
- 26" handrim for 26" wheel € 377.90
A9000205080-006
Attachment fitting to the rim



Curve black anodised, ergonomic handrim profile

- 24" handrim for 24" wheel and 25" wheel € 370.60
H 24 mm
A9000205130-004
- 24" handrim for 24" wheel and 25" wheel € 370.60
H 31 mm, size L
A9000205140-004
- 26" handrim for 26" wheel € 370.60
H 31 mm, size L
A9000205140-006



<p>Curve silver anodised ergonomic handrim profile</p> <p><input type="checkbox"/> 24" handrim for 24" wheel and 25" wheel H 31 mm, size L A9000205160-004</p> <p style="text-align: right;">€ 375.50</p> 	<p>Curve powder-coated, ergonomic handrim profile</p> <p><input type="checkbox"/> = Frame colour (gloss surface) <input type="checkbox"/> = black (gloss surface)</p> <p><input type="checkbox"/> 24" handrim for 24" wheel and 25" wheel H 24 mm A9000205135-004</p> <p style="text-align: right;">€ 432.40</p> <p><input type="checkbox"/> 24" handrim for 24" wheel and 25" wheel H 31 mm, size L A9000205145-004</p> <p style="text-align: right;">€ 432.40</p> <p><input type="checkbox"/> 26" handrim for 26" wheel H 31 mm, size L A9000205145-006</p> <p style="text-align: right;">€ 432.40</p> 	<p>Curve Grip, with Tetra-Grip coating, ergonomic handrim profile</p> <p><input type="checkbox"/> 24" handrim for 24" wheel and 25" wheel H 31 mm size L A9000205150-004</p> <p style="text-align: right;">€ 481.40</p> 
<p>Quadro with Tetra-Grip coating</p> <p><input type="checkbox"/> 24" handrim for 24" wheel and 25" wheel A9000205170-004</p> <p style="text-align: right;">€ 492.90</p> <p><input type="checkbox"/> 25" handrim for 25" wheel A9000205170-005</p> <p style="text-align: right;">€ 492.90</p> <p><input type="checkbox"/> 26" handrim for 26" wheel A9000205170-006</p> <p style="text-align: right;">€ 492.90</p> 	<p>Gekko black anodised</p> <p><input type="checkbox"/> 24" handrim for 24" wheel and 25" wheel A9000205175-004</p> <p style="text-align: right;">€ 477.30</p> <p><input type="checkbox"/> 25" handrim for 25" wheel A9000205175-005</p> <p style="text-align: right;">€ 477.30</p> <p><input type="checkbox"/> 26" handrim for 26" wheel A9000205175-006</p> <p style="text-align: right;">€ 477.30</p> <p>with a robust and replaceable silicone lip, fully integrated into the profile Profile height 31 mm</p> 	<p>Gekko silver anodised</p> <p><input type="checkbox"/> 24" handrim for 24" wheel and 25" wheel A9000205185-004</p> <p style="text-align: right;">€ 488.80</p> <p>with a robust and replaceable silicone lip, fully integrated into the profile Profile height 31 mm</p> 
<p>Gekko S black anodised</p> <p><input type="checkbox"/> 24" handrim for 24" wheel and 25" wheel A9000205195-004</p> <p style="text-align: right;">€ 477.30</p> <p>with a robust and replaceable silicone lip, fully integrated into the profile Profile height 24 mm</p> 	<p>Equipment without handrims</p> <p><input checked="" type="checkbox"/> A9000205990</p>	

Spoke guard

Finger- and spoke guard "transparent"

- for 24" wheel
A9000206300-004 € 191.50
- for 26" wheel
A9000206300-006 € 191.50



Tyres

Schwalbe "RightRun" High-pressure tyre

- 24x1" (540-25)
A9000204001-004
Colour: black
7.5 bar



Schwalbe "RightRun" High-pressure tyre

- 24x1" (540-25)
A9000204000-004
- 25x1" (559-23)
A9000204000-005
- 26x1" (590-25)
A9000204000-006
Colour: Grey, black wall
7.5 bar



Schwalbe "DownTown" Profiled tyres

- 24x1" (540-25)
A9000204010-004
7.5 bar



Schwalbe "MarathonPlus Evolution" with "smart guard" puncture protection

- 24x1" (540-25)
A9000204030-014 € 45.50
- 25x1" (559-25)
A9000204030-015 € 45.50
- 26x1" (590-25)
A9000204030-016 € 45.50
Colour: black
10 bar



Schwalbe "MarathonPlus" with "smart guard" puncture protection

- 24x1" (540-25)
A9000204030-004 € 45.50
Colour: Grey, black wall
10 bar



Schwalbe "One"

- 24x1" (540-25)
A9000204123-004 € 86.00
Colour: black
9 bar



Puncture-proof tyre "solid rubber tyres"

- 24x1" (540-25)
A9000204201-004 € 113.40
Colour: black
Not in combination with the 18 spoke drive
wheel, Spinergy and one-hand drive



Accessories

24" MTB spare wheel set

with double rim (ETRTO 507), aluminium front hub, quick-release axle and stainless steel handrim
Mountain bike tyres, selectively:

A9000203410 € 650.40

24x1.75" Schwalbe "Marathon Plus"
Brake setting compatible with 24x1" wheel



A9000203413 € 650.40

24x2.1" Schwalbe "SMART SAM Sport"
Brake setting not compatible with 24x1" wheel



Through axle with assistance, Large push button

A9000200096 € 97.80

Interlock dimension: 122 / 110 mm
Axle diameter: 12 mm
Not in conjunction with lockable drive wheel
axle clip "Tetra Clip",
Not in combination with one-hand drive



Lockable drive wheel axle clip "Tetra Clip"

A9000206400 € 153.90

Not for Spinergy drive wheels, one-hand
drive, drum brake or Liteline hub



Hand air compressor with pressure gauge

A9000901100 € 98.30

up to 14 bar



Length-adjustable safety belt with buckle

A9000902100 € 74.60



Adjustable safety belt with hook and fastener

A9000902110 € 59.60



Crutch holder with nylon cup

A9000902310 € 127.00

flexible



SIGMA lighting set

A9000903270 € 99.80

Consisting of front light and rear lights,
chargeable via Micro USB socket,
incl. Micro USB charging cable.
Lighting set compliant with road traffic
regulations



Transport bag for Traveller frame

A9030903200 € 225.70

Only in conjunction with caster forks with
quick-release axles



Transport bag for drive wheels

for 24" wheel
A9000903530-004 € 71.90
Ø 76 cm x 2 cm

for 26" wheel
A9000903530-006 € 71.90
Ø 83 cm x 2 cm



Accessory bag

A9000903600 € 70.30

17 cm x 13cm x 5 cm



Locking strap for Traveller

A9030902200 € 18.60

Further accessories, e.g., adaptive bikes, steering attachments, etc. see separate order sheet or www.proactiv-gmbh.de

Notes and remarks:

Location, Date

Signature End customer/dealer

The signature field is intended for the consultant and insured person. This confirms that the intended equipment is intended for the insured person.
- 17 - 2023-02-16 / The prices are plus statutory value-added tax and shipping costs = Included in the basic price = Position selected
Order sheet TRAVELER 4all Ergo Rev. 03 UK