

Im Hofstätt 11
D-72359 Dotternhausen
Phone +49 (0)7427 9480-0
Fax +49 (0)7427 9480-7025
e-mail info@proactiv-gmbh.de
www.proactiv-gmbh.com



SPEEDY 4all **Active easy running rigid frame** **wheelchair**

Maximum user weight limit 120 kg

A9016100000 € 3,820,00

Quotation date: _____

Consultation was carried out by
Staff at the medical supplies shop: _____

PRO ACTIV field representative: _____

Order date: _____

according to GTC PRO ACTIV GmbH

Medical suppliers/company address:

Cust. no.: _____
Name: _____
Street: _____
Postcode / city: _____
Phone: _____
Fax: _____
E-Mail: _____
Contact: _____

Invoicing address: **same as company address**

other (see below)

Cust. no.: _____
Name: _____
Street: _____
Postcode / city: _____
Phone: _____
Fax: _____
E-Mail: _____
Contact: _____

Shipping address: **same as company**
address

Other (see below)

Name: _____
Street: _____
Postcode / city: _____

Customer name/commission:

Surname,
forename: _____
Street: _____
Postcode / city: _____
Phone: _____
Fax: _____
E-Mail: _____
D.O.B: _____
Paying
organisation: _____

Basic size

Body size:

Body height: _____ cm

Weight: _____ kg

Lower leg length: _____ cm
(anatomic dimension: hollow of the knee to the foot sole)

Indication: _____

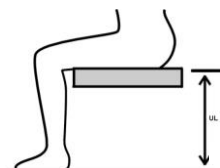

This information is mandatory for further processing.

Wheelchair dimensions:

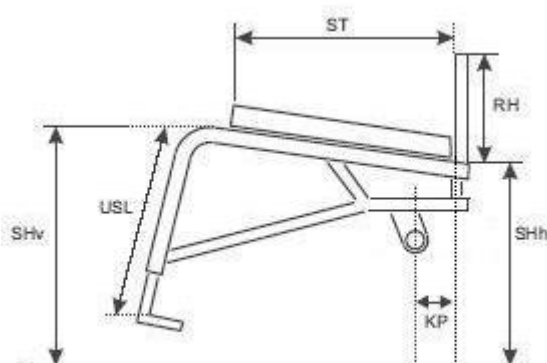

Seat width SB	<input type="checkbox"/> 30	<input type="checkbox"/> 31	<input type="checkbox"/> 32	<input type="checkbox"/> 33	<input type="checkbox"/> 34	<input type="checkbox"/> 35	<input type="checkbox"/> 36	<input type="checkbox"/> 37	<input type="checkbox"/> 38	<input type="checkbox"/> 39
	<input type="checkbox"/> 40	<input type="checkbox"/> 41	<input type="checkbox"/> 42	<input type="checkbox"/> 43	<input type="checkbox"/> 44	<input type="checkbox"/> 45	<input type="checkbox"/> 46			
	The following dimensions are optionally available subject to surcharge:							<input type="checkbox"/> 47	<input type="checkbox"/> 48	<input type="checkbox"/> 49
							<input type="checkbox"/> 51	<input type="checkbox"/> 52		

Seat depth ST	Short frame				Long frame				
	<input type="checkbox"/> 36	<input type="checkbox"/> 37	<input type="checkbox"/> 38	<input type="checkbox"/> 39	<input type="checkbox"/> 40	<input type="checkbox"/> 41	<input type="checkbox"/> 42	<input type="checkbox"/> 43	<input type="checkbox"/> 44
	<input type="checkbox"/> 40	<input type="checkbox"/> 41	<input type="checkbox"/> 42	<input type="checkbox"/> 43	<input type="checkbox"/> 45	<input type="checkbox"/> 46	<input type="checkbox"/> 47	<input type="checkbox"/> 48	

Back height RH	<input type="checkbox"/> 20	<input type="checkbox"/> 21	<input type="checkbox"/> 22	<input type="checkbox"/> 23	<input type="checkbox"/> 24	<input type="checkbox"/> 25	<input type="checkbox"/> 26	<input type="checkbox"/> 27	<input type="checkbox"/> 28	<input type="checkbox"/> 29
	<input type="checkbox"/> 30	<input type="checkbox"/> 31	<input type="checkbox"/> 32	<input type="checkbox"/> 33	<input type="checkbox"/> 34	<input type="checkbox"/> 35	<input type="checkbox"/> 36	<input type="checkbox"/> 37	<input type="checkbox"/> 38	<input type="checkbox"/> 39
	<input type="checkbox"/> 40	<input type="checkbox"/> 41	<input type="checkbox"/> 42	<input type="checkbox"/> 43	<input type="checkbox"/> 44	<input type="checkbox"/> 45	<input type="checkbox"/> 46	<input type="checkbox"/> 47	<input type="checkbox"/> 48	

Lower leg length USL	<input type="checkbox"/> 37	<input type="checkbox"/> 38	<input type="checkbox"/> 39	<input type="checkbox"/> 40	<input type="checkbox"/> 41	<input type="checkbox"/> 42	<input type="checkbox"/> 43
	<input type="checkbox"/> 44	<input type="checkbox"/> 45	<input type="checkbox"/> 46	<input type="checkbox"/> 47	<input type="checkbox"/> 48	<input type="checkbox"/> 49	<input type="checkbox"/> 50

Seat height back SHh	<input type="checkbox"/> 39	<input type="checkbox"/> 40	<input checked="" type="checkbox"/> 41	<input type="checkbox"/> 42	<input type="checkbox"/> 43				
	The following dimensions are optionally available subject to surcharge:					<input type="checkbox"/> 44	<input type="checkbox"/> 45	<input type="checkbox"/> 46	<input type="checkbox"/> 47

Seat height front SHv	<input type="checkbox"/> 44	<input type="checkbox"/> 45	<input type="checkbox"/> 46	<input checked="" type="checkbox"/> 47	<input type="checkbox"/> 48	<input type="checkbox"/> 49	<input type="checkbox"/> 50	<input type="checkbox"/> 51	<input type="checkbox"/> 52
------------------------------	-----------------------------	-----------------------------	-----------------------------	--	-----------------------------	-----------------------------	-----------------------------	-----------------------------	-----------------------------

Tipping point KP (Front of back tube up to axis middle drive wheel)	<input type="checkbox"/> 1	<input type="checkbox"/> 2	<input type="checkbox"/> 3	<input type="checkbox"/> 4	<input type="checkbox"/> 5	<input type="checkbox"/> 6	<input type="checkbox"/> 7	<input checked="" type="checkbox"/> 8	<input type="checkbox"/> 9	<input type="checkbox"/> 10
---	----------------------------	----------------------------	----------------------------	----------------------------	----------------------------	----------------------------	----------------------------	---------------------------------------	----------------------------	-----------------------------

Please cross on the appropriate dimension (all dimensions are specified in cm).

Underlined values are standard settings.

The values SHh and SHv may deviate from the specified values depending on the wheel size and wheel camber! Special dimensions possible upon request.

Frame colour – one-colour design

Information about current colour designs and example images at: www.proactiv-gmbh.de/farben.php

frame colour: Selection from colour palette

Frame colour is specified when ordering

A9000100170-000

Powder coatings

White RAL 9016

gloss A9000100170-023

matt A9000100170-123 € 40.10

Brilliant silver

gloss A9000100170-011

Anthracite RAL 7016

gloss A9000100170-001

matt A9000100170-101 € 40.10

Black RAL 9005

gloss A9000100170-003

matt A9000100170-019 € 40.10

Pure orange RAL 2004

gloss A9000100170-022

matt A9000100170-122 € 40.10

Pink magenta RAL 4010

gloss A9000100170-037

matt A9000100170-137 € 40.10

Pastel blue RAL 5024

gloss A9000100170-036

matt A9000100170-136 € 40.10

Lemon green

gloss A9000100170-005

matt A9000100170-105 € 40.10

Yellow RAL 1023

gloss A9000100170-046

matt A9000100170-146 € 40.10

Red RAL 3001

gloss A9000100170-047

matt A9000100170-147 € 40.10

Lagoon blue

gloss A9000100170-052

matt A9000100170-152 € 40.10

Athletic grey

gloss A9000100170-050

matt A9000100170-150 € 40.10

Muddy grey

gloss A9000100170-051

matt A9000100170-151 € 40.10

“Dormant” powder coatings

Deep black, silver effect

gloss A9000100170-007

Sky blue

gloss A9000100170-017

Marine blue

gloss A9000100170-045

matt A9000100170-145 € 40.10

Electric green

gloss A9000100170-015

matt A9000100170-115 € 40.10

Violet

gloss A9000100170-044

Fire red

gloss A9000100170-018

matt A9000100170-118 € 40.10

Frame colour – “liquid coating” one-colour design

€ 323.20

Storm (ice blue)

gloss A9000100170-500

matt A9000100170-501

Coffee

gloss A9000100170-520

matt A9000100170-521

Prairie (rose gold)

gloss A9000100170-504

matt A9000100170-505

Pearl (mother of pearl-white)

gloss A9000100170-524

matt A9000100170-525

Berry

gloss A9000100170-526

matt A9000100170-527

Blue ocean

gloss A9000100170-522

matt A9000100170-523

Emerald (emerald green)

gloss A9000100170-514

matt A9000100170-515

Mint

gloss A9000100170-528

matt A9000100170-529

Chilli

gloss A9000100170-516

matt A9000100170-517

Frame colour – two colour designs

Note: Frames with two colour designs in the gloss level of the design colour.

- Two-colour design comprising one basic colour (on the back of the frame) and one design colour (on the front of the frame)** € 248.30

Please select from the following colours:

Base colour (on the rear frame)

White RAL 9016 <input type="checkbox"/> A9000100170-200	Brilliant silver <input type="checkbox"/> A9000100170-201	Anthracite RAL 7016 <input type="checkbox"/> A9000100170-202
Black RAL 9005 <input type="checkbox"/> A9000100170-203	Pastel blue RAL 5024 <input type="checkbox"/> A9000100170-206	Lemon green <input type="checkbox"/> A9000100170-207
Yellow RAL 1023 <input type="checkbox"/> A9000100170-208	Lagoon blue <input type="checkbox"/> A9000100170-212	Athletic grey <input type="checkbox"/> A9000100170-210
Muddy grey <input type="checkbox"/> A9000100170-211		

Design colour (on the front frame)

Black RAL 9005 <input type="checkbox"/> gloss A9000100170-259 <input type="checkbox"/> matt A9000100170-260	Lemon green <input type="checkbox"/> gloss A9000100170-250 <input type="checkbox"/> matt A9000100170-251	Chilli <input type="checkbox"/> gloss A9000100170-253 <input type="checkbox"/> matt A9000100170-254
Pure orange RAL 2004 <input type="checkbox"/> gloss A9000100170-255 <input type="checkbox"/> matt A9000100170-256	Coffee <input type="checkbox"/> gloss A9000100170-278 <input type="checkbox"/> matt A9000100170-279	Mint <input type="checkbox"/> gloss A9000100170-286 <input type="checkbox"/> matt A9000100170-287
Emerald (emerald green) <input type="checkbox"/> gloss A9000100170-274 <input type="checkbox"/> matt A9000100170-275	Storm (ice blue) <input type="checkbox"/> gloss A9000100170-264 <input type="checkbox"/> matt A9000100170-265	Prairie (rose gold) <input type="checkbox"/> gloss A9000100170-266 <input type="checkbox"/> matt A9000100170-267
Pearl (mother of pearl-white) <input type="checkbox"/> gloss A9000100170-282 <input type="checkbox"/> matt A9000100170-283	Berry <input type="checkbox"/> gloss A9000100170-284 <input type="checkbox"/> matt A9000100170-285	Blue ocean <input type="checkbox"/> gloss A9000100170-280 <input type="checkbox"/> matt A9000100170-281

Colour - Attachment parts

Note: If no specifications have been made, the caster fork and bearing block are mounted in black.

Drive wheel: Aluminium rim, hub and spokes

- Black A9000100171-003

Caster fork and bearing block

- Silver A9000100173-011
 Black A9000100173-003

Attachment parts colour design according to customer desires:

Drive wheel: Aluminium rim and design inlet¹

- Pure orange RAL 2004 A9000100171-022 € 193.10
 White RAL 9016 A9000100171-023 € 193.10
 Frame colour A9000100171-999 € 230.80
 Selection of single colour coating (deviating from the frame colour) A9000100171-998 € 267.10
Colour: _____
A9000100170-

Caster wheel: 5" aluminium rim² (3-spoke design)

- Pure orange RAL 2004 A9000100174-022 € 44.40
 White RAL 9016 A9000100174-023 € 44.40
 Frame colour A9000100174-999 € 69.50
 Selection of single colour coating (deviating from the frame colour) A9000100174-998 € 80.60
Colour: _____
A9000100170-

Special colour requests (frame or attachment parts)

Frame colour individual procurement Selection from RAL colour palette

- A9000100170-100 € 383.10

Degree of gloss

- gloss
 matt

Colour designation

RAL number

Note: Attachment parts **not** possible in design colours

¹ Only in conjunction with Liteline hub (for drive wheel aluminium rim with 18 or 36 spokes, object).

² Only in conjunction with 5" caster wheel aluminium rim 3-spoke design easy running A9000501200 or good shock absorption A9000501210

Frames

Note: Footrest area with V-shape $x = SB - (0.25 \times USL + 6 \text{ cm})$

Straight front end

A9016100012-K*
Knee angle 95°
Min. 4 cm seat slope and
max. caster wheel size 5"

A9016100010-K*
Knee angle 105°



Front end V-shape

A9016100020-K* € 280.80
Knee angle 95°
from SB 33 cm

A9016100023-K* € 280.80
Knee angle 105°
from SB 33 cm

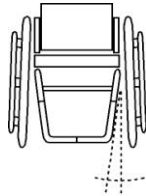

Custom-made seat width dimension 47 - 52 cm

A9016100060-K € 282.90
with frame reinforcement
maximum user weight limit 120 kg

Push handles

Back tube with integrated handles

A9000401051-K € 120.60
straight

Also possible with lumbar curvature:

- 1 cm
- 2 cm
- 3 cm



Aluminium push handles fixed in back tube

A9000401050 € 120.60
from RH 23 cm



Push handles, horizontally screwed in back tube

A9000401076 € 223.60
can be unscrewed



Safety push handles with continuous height adjustment

A9000401060 € 200.10

Mount in the back tube
from RH 30 cm with adaptable back
from RH 43 cm with back shell
Starting at a back height of 35 cm for back tube
with lordosis support



Safety push handles back-positioned length 45 cm

A9000401075 € 344.80

continuous height adjustment,
Safety push handle holder mounted on the
back cross bar
Up to seat width of 42 cm or body weight of
95 kg
Cannot be swivelled in conjunction with
armrest



Backrest

Folding backrest

A9000400011
7-way angle adjustment,
with integrated plastic coated
Aluminium side sections



Back tube with lumbar curvature

A9000400005-K € 105.80

- 1 cm
- 2 cm
- 3 cm



Back equipment

Adaptable back with back padding

A9000802010-K
Cover: Black, breathable, open surface
Equipment with back cross bar



Raised back + 3 - 5 cm

A9000802100 € 144.40
for the nominal back height dimension
Only in combination with height adjustable
push handles



Equipment without back upholstery and back padding or back system

A9000802011 € - 53.00
Equipment with back cross bar

Other back systems, such as ergonomic back shell
see separate order sheet: "PRO ACTIV seat and back systems"



You will find our PRO ACTIV transport restraint systems
on our separate "Transport restraint systems" order sheet



Seat upholstery

Body Contour

A9000801025-K
Approved up to a body weight of 120 kg

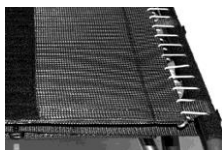

Open belt system

A9000801010-K € 71.10

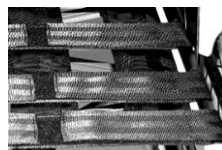

Equipment without seat upholstery

A9000801050



Seat cushion

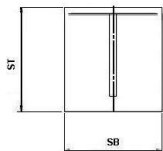

Seat cushion in rectangular contour
Inlet: Standard

A9000805180-K* € 106.60

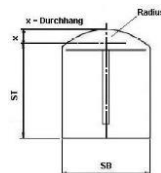

Seat cushion with radius contour
Inlet: Standard

A9000800300-K* € 148.00

Seat cushion height:

3 cm 5 cm
 4 cm 6 cm

Seat cushion in rectangular contour
Inlet: Anti-Decubitus

up to 30x30 cm
A9000805204-K* € 276.20

>30x30 up to
50x50 cm
A9000805200-K* € 401.90

Seat cushion with radius contour
Inlet: Anti-Decubitus

up to 30x30 cm
A9000800311-K* € 326.50

>30x30 up to
50x50 cm
A9000800310-K* € 443.70

Seat cushion height:

4 cm
 6 cm

Cover:

Black, breathable, open surface
 Black, breathable, closed surface
If not specified, the cover fabric "black, breathable, open surface" is delivered.

Seat cushion is existing

Brand/type _____

Cushion height _____ cm

You can also find the seat cushions on our separate "PRO ACTIV Seat and Back Systems" order sheet

Clothing guard

Aluminium clothing guard removable via lock function

Adjustable following wheel arch
Only in combination with folding backrest



in anthracite matt

A9000403210-K € 224.90

in frame colour (basic colour with two-colour design)

A9000403211-K € 287.60

in design colour (only possible with frame colour in two-colour design)

A9000403212-K € 319.00

Carbon clothing guard removable via lock function

A9000400012-K € 521.20

Adjustable following wheel arch
Only in combination with folding backrest



Armrests

Armrest, height adjustable, integrated in the clothing guard

Including aluminium clothing guard
with arm padding 25 cm long
Removable via lock function
Only in combination with folding backrest



in anthracite matt

A9000400008-K € 526.70

In frame colour (basic colour with two-colour design)

A9000400009-K € 575.00

in design colour (only with frame colour in two-colour design)

A9000400010-K € 599.20

Armrest, height adjustable, integrated in the clothing guard

A9000400018-K € 797.00

Including carbon clothing guard
with arm padding 25 cm long
Removable via lock function
Only in combination with folding backrest

Armrests folding up, removable

A9000403141-K € 331.50

with arm padding 25 cm long
Positioning: upper arm padding edge approx. 25 to 31 cm above the seat tube, adjustable in 1.5 cm steps
Not possible in combination with back-positioned safety push handles



Axle plate

Standard equipment with 12 mm sockets/axle. Further axle plate on request.

Standard axle plate

A9016201000
Rear seat height approx. 39 to 43 cm
(for 24" wheel)

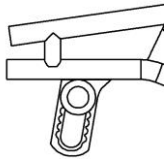

Long axle plate

A9016201020 € 217.00
Rear seat height approx. 43 to 47 cm
(for 24" wheel)

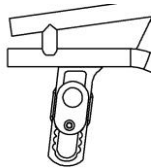

Removable wheelbase extension Speedy 4all / 4you

A9016102001 € 537.50
wheel position displacement approx. 14 cm
4° / 6° camber integrated, adjustable track



Wheel camber

*Total width with tight-mounted handrim

1° drive wheel camber

A9016202010
Total width = approx. SB + 20 cm*

4° drive wheel camber

A9016202030
Total width = approx. SB + 26 cm*

6° drive wheel camber

A9016202040
Total width = approx. SB + 30 cm*

E-adaptations

Preparation for "e-motion" mounting

A9016201200-K € 465.00

Equipment: e-motion torque support, 1/2" axle and socket length 50.8 mm (2")
PRO ACTIV and Alber recommend anti-tipping supports are installed in pairs. Please choose "Adaptations" under the selection.

Preparation for "e-fix" mounting

A9016201210-K € 465.00

Equipment: 1/2" axle, socket length 50.8 mm (2") and e-fix torque support.
PRO ACTIV and Alber recommend anti-tipping supports are installed in pairs. Please choose "Adaptations" under the selection.
Please order Alber anti-tipping supports and corresponding components direct from Alber.

Wheelchair delivery to

Alber GmbH
(Please also enter on p.1 under "Shipping address, other")
 Specialist dealer

Brake system

Brake system push to lock Standard brake handle

A9000701010-001



Brake system push to lock Long brake lever

A9000701010-002



Brake system push to lock Low brake handle

A9000701010-003



Brake lever at 20°

A9000700002
Only in conjunction with knee lever brake system, standard brake lever, long or low.



Brake system push to lock Brake handle to flip-down

A9000706008 € 146.70
Length: 9 cm



Drum brake

A9000702010-K* € 438.30

Operating from the push handle
Total wheelchair width (see selection "Wheel camber") + 3cm
Depending on the seat height, the long wheel plate is mounted in order to protect the drum brake anchors.
Please note:
- Only in combination with drive wheel aluminium 36-spoke rim wheel
- Not in combination with one-hand drive, e-fix or e-motion



Footrest

Continuous footrest

A9016601010-K*
with tubular resting bracket
height adjustable +/- 3 cm
for KW 95° from USL 34 cm
for KW 105° from USL 39 cm
For equipment of the footrest with "Rubber
coated footrest", please select under "Footplate
support accessories"



Footrest folding up to one side

A9016601300-K* € 160.80
with continuous tubular resting bracket,
height adjustable +/- 3 cm,
can be swung away,
cannot be removed
for KW 95° from USL 37 cm
for KW 105° from USL 42 cm
with V-shape from SB 40 cm
For equipment of the footrest with "Rubber
coated footrest", please select under "Footplate
support accessories"



Footbar folds up to the rear with spring locking mechanism

A9016602005-K* € 265.70
with continuous tubular resting bracket
for KW 105° from USL 42 cm
for KW 95° from USL 38 cm
For equipment of the footrest with "Rubber
coated footrest", please select under "Footplate
support accessories"



Footrest folding back to the rear

A9016602010-K* € 284.70
with continuous tubular resting bracket and 20
mm operating lever
for KW 95° from USL 38 cm
for KW 105° from USL 42 cm
with V-shape from SB 33 cm
with V-shape from SB 38 cm
from 20 cm
For equipment of the footrest with "Rubber
coated footrest", please select under "Footplate
support accessories"!



Divided footrest

A9016603200-K € 311.40
with rubber coated footplate,
height adjustable +/- 3cm, angle adjustment,
can be pivoted outwards and folded up to the
side,
including frame reinforcement
for KW 95° from USL 37 cm
for KW 105° from USL 42 cm
with V-shape from SB 40 cm

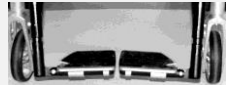

"Swing away" footrest

A9016604100-K € 374.20
with rubber coated footplate,
separated in the middle, can be folded to the
side, removable,
can be folded up, height-adjustable, angle-
adjustable
including frame reinforcement
from USL 34 cm



Footrest accessories

Rubber coated footplate

A9000610000-K € 116.40
bolted, angle-adjustable
Depth: 14 cm



Footplate side stop

A9000610100 € 55.20
adjustable
only in combination with rubber coated
footplate



Adaptations

Anti-tipping support

right side
A9000300100-K001 € 156.40

left side
A9000300100-K002 € 156.40

with tension spring and universal adapter
pivotable

For optimum pivoting behaviour, the
seat slope should be >3 cm



Preparation for mounting the anti-tipping support with lifting function from Alber (e-fix, e-motion)

A9016300105 € 274.40

Universal adapter is prepared for mounting the
anti-tipping support with lifting function from
Alber.

Supplied without anti-tipping support and anti-
tipping support mount.

On the customer side, please order the anti-
tipping support by Alber



Transit wheels

A9000301100 € 304.80

with universal adapter, removable
not in combination with anti-tipping support



Tilting clamp

right side
A9000302100-001 € 129.50

left side
A9000302100-002 € 129.50

with universal adapter and Quick pin
not in combination with anti-tipping support,
right side or left side



3" caster wheel

3" Skate wheel (80 mm)

A9000501110 € 65.40

puncture-proof



4" caster wheel

4" caster wheel "Standard" solid rubber black

A9000501011-004
(82A), puncture-proof



4" Skate wheel (100 mm)

A9000501120 € 65.40

puncture-proof













4" safety light-up wheel (100 mm)

A9000501220 € 87.60

puncture-proof



4" Frog Legs caster wheel (100 mm) <input type="checkbox"/> A9000501230 € 168.20 with replaceable rubber 6 mm, puncture-proof Colour: black, silver rim Incl. hair guard spacer (5.3 mm) 		
5" caster wheel		
5" caster wheel "Standard" PU black <input checked="" type="checkbox"/> A9000501036-005 (82A), puncture-proof 	5" Caster wheel "Standard" PU grey <input checked="" type="checkbox"/> A9000501031-005 (82A), puncture-proof 	5" Caster wheel "2 components" <input type="checkbox"/> A9000501030 € 52.00 puncture-proof 
5" safety light-up wheel (125 mm) <input type="checkbox"/> A9000501221 € 87.60 puncture-proof 	5" Aluminium rim 3-spoke design "easy running" <input type="checkbox"/> Silver, anodised A9000501200 € 160.50 <input type="checkbox"/> black A9000501201 € 160.50 With exchangeable rubber ring 3 mm hard, puncture-proof Incl. hair guard spacer (3 mm) 	5" aluminium rim 3-spoke design "Good shock absorption" <input type="checkbox"/> Silver, anodised A9000501210 € 166.30 <input type="checkbox"/> black A9000501211 € 166.30 with replaceable rubber 6 mm medium hard, puncture-proof Incl. hair guard spacer (3 mm) 
5" Frog Legs caster wheel (125 mm) <input type="checkbox"/> A9000501232 € 168.20 with replaceable rubber 6 mm, puncture-proof Colour: black, silver rim Incl. hair guard spacer (5.3 mm) 		
6" caster wheel		
6" Caster wheel "Standard" PU grey <input checked="" type="checkbox"/> A9000501010-006 (82A), puncture-proof 	6" caster wheel "pneumatic tyre" <input type="checkbox"/> A9000501050 € 52.90 SH front min. 42 cm 	6" caster wheel "Flexel System" <input type="checkbox"/> A9000501070 € 52.90 puncture-proof 

Caster fork

Caster fork colours, see "Component colours"

Caster fork Standard

A9000500100-K001
with screwed axle

A9000500100-K002 € 154.80
with quick-release axle



Heavy duty caster fork

For high loads or
when using additional electric drives

A9000510111-K001 € 49.90
with screwed axle

A9000510111-K002 € 202.40
with quick-release axle



Suspension fork

incl. 5" aluminium rim "good shock absorption"

A9000500160-K001 € 466.90
with screwed axle

A9000500160-K002 € 570.40
with quick-release axle



Caster fork spare wheel "Standard"

A9000500300-K € 274.40
Standard caster forks with quick-release axles



Caster fork spare wheel "Heavy Duty"

A9000500301-K € 312.50
Heavy duty caster forks with quick-release
axles



The spare caster fork does not have a caster
wheel.
In case a caster wheel is requested, please put
a cross on a second selection in the category
"Caster wheels".

Track distance

Caster wheel track extension



A9000500400* € 54.70
10 mm per side

A9000500401* € 54.70
15 mm per side

A9000500410* € 54.70
20 mm per side

Drive wheels

Information on further rim types, versions and availabilities under: www.proactiv-gmbh.de

Drive wheel, 18 spoke aluminium rim

24" (ETRTO 540)
A9000203122
with Liteline hub, spoked radially

Not in combination with:

- Puncture-proof tyres
- One-hand drive
- Drum brake
- Adaptive bike

only up to a body weight of 70 kg:

Sturz \ Gewicht	1°	4°	6°	8°	10°
bis 50 Kg	✓	✓	✓	✓	✓
51 - 60 Kg	✓	✓	✓	✓	
61 - 70 Kg	✓	✓			



Drive wheel, 36 spoke aluminium rim

24" (ETRTO 540)
A9000203000
Up to 120 kg body weight with Liteline hub (left
image)
Over 120 kg body weight with aluminium high
flange (right image)
radially spoked



Drive wheel double rim 36 spokes



24" (ETRTO 540)
A9000203100 € 145.90

25" (ETRTO 559)
A9000203200 € 145.90

26" (ETRTO 590)
A9000203300 € 145.90

with aluminium front hub,
radially spoked
Use with higher loads and
body weight > 120 kg



<p>Spinergy running wheel "Spox Sport" with 24 PBO spokes; rim, hub and spokes in black</p> <p><input type="checkbox"/> 24" (ETRTO 540) A9000203550 € 725.00</p> <p><input type="checkbox"/> 25" (ETRTO 559) A9000201559 € 725.00</p> <p><input type="checkbox"/> 26" (ETRTO 590) A9000203555 € 725.00</p> 	<p>Spinergy "Everyday Light Extreme" with 12 PBO spokes; rim and hub in black, spokes white</p> <p><input type="checkbox"/> 24" (ETRTO 540) A9000203554 € 885.00</p> 	<p>Spinergy "Everyday Light Extreme" with 12 PBO spokes; rim, hub and spokes in black</p> <p><input type="checkbox"/> 24" (ETRTO 540) A9000203552 € 885.00</p> 
---	---	---

Handrims

x = dimension handrim attachment

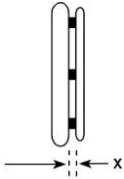

Handrim attachment
General:

- x = 11 mm
 x = 19 mm

Handrim attachment
Curve handrim:

- x = 10 mm
 x = 18 mm

Unless otherwise specified, the handrim is mounted wide (19 mm / 18 mm)

Stainless steel Ø 20 mm

- 24" handrim for 24" wheel and 25" wheel A9000205010-004
- 26" handrim for 26" wheel A9000205010-006



Aluminium Ø 19 mm silver anodised

- 24" handrim for 24" wheel and 25" wheel A9000205019-004



Aluminium Ø 19 mm powder coated in frame colour

(basic colour with two-colour design)

- = Gloss surface
 = Matt surface

Note: Matt coating is not recommended due to the low grip.

- 24" handrim for 24" wheel and 25" wheel € 63.10 A9000205020-004
- 26" handrim for 26" wheel € 63.10 A9000205020-006



Aluminium Ø 19 mm polished and hard-anodised

- 24" handrim for 24" wheel and 25" wheel € 152.50 A9000205030-004
- 26" handrim for 26" wheel € 152.50 A9000205030-006



Titanium Ø 19 mm

- Handrim for 24" wheel and 25" wheel € 310.30 A9000205040-004
- 26" handrim for 26" wheel € 310.30 A9000205040-006











Silicone handrim cover

- for 24" handrim € 215.20 A9000205100-004
- for 26" handrim € 215.20 A9000205100-006

Surface without structure, compatible with handrim Ø 19 mm or Ø 20 mm.



<p>Ultra-Grip “very grippy”</p> <p><input type="checkbox"/> 24” handrim for 24” wheel and 25” wheel A9000205070-004 € 372.10</p> <p><input type="checkbox"/> 26” handrim for 26” wheel A9000205070-006 € 372.10</p> 	<p>Ergo-Grip</p> <p><input type="checkbox"/> 24” handrim for 24” wheel and 25” wheel A9000205080-004 € 377.90</p> <p><input type="checkbox"/> 26” handrim for 26” wheel A9000205080-006 € 377.90 Attachment fitting to the rim</p> 	<p>Curve black anodised, ergonomic handrim profile</p> <p><input type="checkbox"/> 24” handrim for 24” wheel and 25” wheel H: 24 mm A9000205130-004 € 370.60</p> <p><input type="checkbox"/> 24” handrim for 24” wheel and 25” wheel H: 31 mm, size L A9000205140-004 € 370.60</p> <p><input type="checkbox"/> 26” handrim for 26” wheel H: 31 mm, size L A9000205140-006 € 370.60</p> 
<p>Curve silver anodised ergonomic handrim profile</p> <p><input type="checkbox"/> 24” handrim for 24” wheel and 25” wheel H: 31 mm, size L A9000205160-004 € 375.50</p> 	<p>Curve powder-coated, ergonomic handrim profile</p> <p><input type="checkbox"/> = Frame colour (gloss surface) <input type="checkbox"/> = black (gloss surface)</p> <p><input type="checkbox"/> 24” handrim for 24” wheel and 25” wheel H: 24 mm A9000205135-004 € 432.40</p> <p><input type="checkbox"/> 24” handrim for 24” wheel and 25” wheel H: 31 mm, size L A9000205145-004 € 432.40</p> <p><input type="checkbox"/> 26” handrim for 26” wheel H: 31 mm, size L A9000205145-006 € 432.40</p>  <p>Profilhöhe H: 24mm oder 31mm</p>	<p>Curve Grip, with Tetra-Grip coating, ergonomic handrim profile</p> <p><input type="checkbox"/> 24” handrim for 24” wheel and 25” wheel H 31 mm size L A9000205150-004 € 481.40</p> 

<p>Quadro with Tetra-Grip coating</p> <p><input type="checkbox"/> 24" handrim for 24" wheel and 25" wheel A9000205170-004 € 492.90</p> <p><input type="checkbox"/> 25" handrim for 25" wheel A9000205170-005 € 492.90</p> <p><input type="checkbox"/> 26" handrim for 26" wheel A9000205170-006 € 492.90</p> 	<p>Gekko black anodised</p> <p><input type="checkbox"/> 24" handrim for 24" wheel and 25" wheel A9000205175-004 € 477.30</p> <p><input type="checkbox"/> 25" handrim for 25" wheel A9000205175-005 € 477.30</p> <p><input type="checkbox"/> 26" handrim for 26" wheel A9000205175-006 € 477.30 with a robust and replaceable silicone lip, fully integrated into the profile</p> 	<p>Gekko silver anodised</p> <p><input type="checkbox"/> 24" handrim for 24" wheel and 25" wheel A9000205185-004 € 488.80 with a robust and replaceable silicone lip, fully integrated into the profile</p> 
<p>Gekko S</p> <p><input type="checkbox"/> 24" handrim for 24" wheel and 25" wheel A9000205195-004 € 477.30 black with a robust and replaceable silicone lip, fully integrated into the profile Profile height 24 mm</p> 	<p>Equipment without handrims</p> <p><input checked="" type="checkbox"/> A9000205990</p>	
<p>Spoke guard</p>		
<p>Finger- and spoke guard "transparent"</p> <p><input type="checkbox"/> for 24" wheel A9000206300-004 € 191.50</p> <p><input type="checkbox"/> for 26" wheel A9000206300-006 € 191.50</p> 		

Tyres

Schwalbe "RightRun" High-pressure tyre

- 24x1" (540-25)
A9000204001-004
Colour: black
7.5 bar



Schwalbe "RightRun" High-pressure tyre

- 24x1" (540-25)
A9000204000-004
- 25x1" (559-25)
A9000204000-005
- 26x1" (590-25)
A9000204000-006
Colour: Grey, black
7.5 bar



Schwalbe "DownTown" Profiled tyres

- 24x1" (540-25)
A9000204010-004
7.5 bar



Schwalbe "MarathonPlus Evolution" with "smart guard" puncture protection

- 24x1" (540-25) € 45.50
A9000204030-014
- 25x1" (559-25) € 45.50
A9000204030-015
- 26x1" (590-25) € 45.50
A9000204030-016
Colour: black
10 bar



Schwalbe "MarathonPlus" with "smart guard" puncture protection

- 24x1" (540-25) € 45.50
A9000204030-004
Colour: Grey, black wall
10 bar



Schwalbe "One"

- 24x1" (540-25) € 86.00
A9000204123-004
Colour: black
9 bar

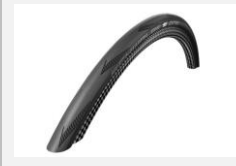

Puncture-proof tyre "solid rubber tyres"

- 24x1" (540-25) € 113.40
A9000204201-004
Colour: black
Not in combination with the 18 spoke drive
wheel!
Not in combination with Spinergy drive wheel!



Accessories

24" MTB spare wheel set

with double rim (ETRTO 507), aluminium front hub, quick-release axle and stainless steel handrim
Mountain bike tyres, selectively:

- A9000203410 € 650.40
24x1.75" Schwalbe "Marathon Plus"
Brake setting compatible with 24x1" wheel











- A9000203413 € 650.40
24x2.1" Schwalbe "SMART SAM Sport"
Brake setting not compatible with 24x1" wheel



NOTE: We charge a surcharge for the
use of drum brakes

- A9000200004 € 210.60

<p>Through axle with assistance, Large push button</p> <p><input type="checkbox"/> A9000200096 € 97.80</p> <p>Interlock dimension: 122 / 110 mm Axle diameter: 12 mm Not in conjunction with lockable drive wheel axle clip "Tetra Clip" Not in combination with one-hand drive</p> 	<p>Lockable drive wheel axle clip "Tetra Clip"</p> <p><input type="checkbox"/> A9000206400 € 153.90</p> <p>Not for Spinergy drive wheels</p> 	<p>Hand air compressor with pressure gauge</p> <p><input type="checkbox"/> A9000901100 € 98.30</p> <p>up to 14 bar</p> 
<p>Length-adjustable safety belt with buckle</p> <p><input type="checkbox"/> A9000902100 € 74.60</p> 	<p>Adjustable safety belt with hook and fastener</p> <p><input type="checkbox"/> A9000902110 € 59.60</p> 	<p>Crutch holder with nylon cup</p> <p><input type="checkbox"/> A9000902310 € 127.00</p> <p>flexible</p> 
<p>SIGMA lighting set</p> <p><input type="checkbox"/> A9000903270 € 99.80</p> <p>Consisting of front light and rear lights, chargeable via Micro USB socket, incl. Micro USB charging cable. Lighting set compliant with road traffic regulations</p> 	<p>Transport bag for drive wheels</p> <p><input type="checkbox"/> for 24" wheel A9000903530-004 € 71.90 Ø 76 cm x 2 cm</p> <p><input type="checkbox"/> for 26" wheel A9000903530-006 € 71.90 Ø 83 cm x 2 cm</p> 	<p>Accessory bag</p> <p><input type="checkbox"/> A9000903600 € 70.30</p> <p>17 cm x 13cm x 5 cm</p> 
<p>Further accessories, e.g., adaptive bikes, steering attachments, etc. see separate order sheet or www.proactiv-gmbh.com</p>		

Notes and remarks:

Location, Date

Signature End customer/dealer

The signature field is intended for the consultant and insured person. This confirms that the intended equipment is intended for the insured person.

- 17 - 2023-02-16 / The prices are plus statutory value-added tax and shipping costs = Included in the basic price = Position selected

Order sheet SPEEDY 4all Rev. 06 UK