

Im Hofstätt 11
 D-72359 Dotternhausen
 Phone +49 (0)7427 9480-0
 Fax +49 (0)7427 9480-7025
 e-mail info@proactiv-gmbh.de
 www.proactiv-gmbh.com



SPEEDY F2

**Lightweight rigid frame wheelchair
 with individual frame geometry, made to measure
 Permanently welded chassis**

Maximum user weight limit 120 kg

A9015100000 € 5,120.00

Quotation date: _____
**Consultation was carried out by
 Staff at the medical supplies shop:** _____
PRO ACTIV field representative: _____

Order date: _____
 according to GTC PRO ACTIV GmbH

Medical suppliers/company address:

Cust. no.: _____
 Name: _____
 Street: _____
 Postcode / city: _____
 Phone: _____
 Fax: _____
 E-Mail: _____
 Contact: _____

Invoicing address: **same as company address**
 other (see below)

Cust. no.: _____
 Name: _____
 Street: _____
 Postcode / city: _____
 Phone: _____
 Fax: _____
 E-Mail: _____
 Contact: _____

Shipping address: **same as company
 address**
 Other (see below)

Name: _____
 Street: _____
 Postcode / city: _____

Body size:

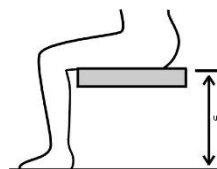

Body height: _____ cm

Weight: _____ kg

Lower leg length: _____ cm
 (anatomic dimension: hollow of the knee to the foot sole):

Indication: _____

This information is mandatory for further processing.

Customer name/commission:

Surname, forename: _____
 Street: _____
 Postcode / city: _____
 Phone: _____
 Fax: _____
 E-Mail: _____
 D.O.B: _____
 Paying organisation: _____

Individual frame geometry classic:

A9015110000-K*

Caster wheel bearing block angle can be adjusted

Caster wheel bearing blocks welded

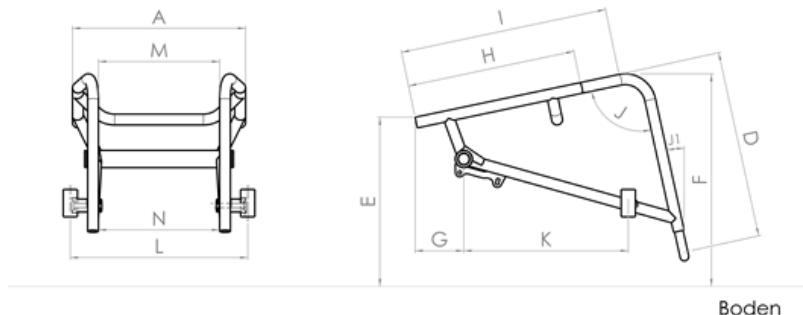

Individual frame geometry oversized:

A9015120000

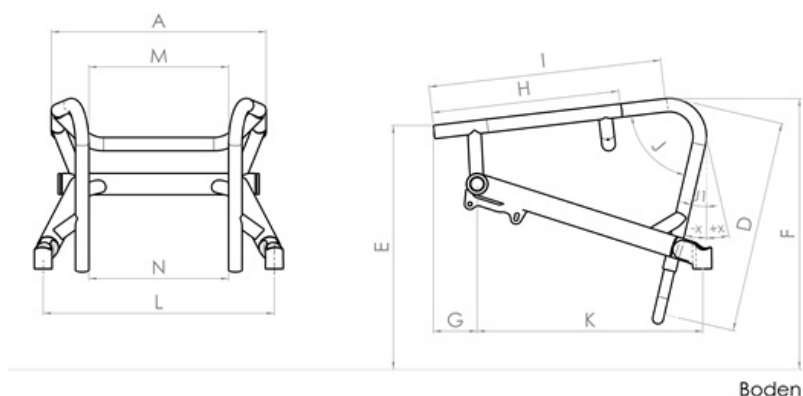

As standard, the frame is equipped with base retention plate.

Equipment without base plate (explicitly requested) A9015100001

For "equipment without base plate", no subsequent adaptations can be retrofitted (anti-tipping supports, transit roller, wheelbase extension, etc.).

Wheelchair dimensions:

- | | | | |
|--|----------|--|----------|
| A: SB seat width | _____ cm | H: Start frame retraction
(I - min. 6 cm) | _____ cm |
| B: ST seat depth | _____ cm | I: Frame length up to front frame bar | _____ cm |
| C: RH back height | _____ cm | J: KW knee angle | _____ ° |
| D: USL lower leg length | _____ cm | or | |
| E: SHh seat height back | _____ cm | J1: Angle of the front framework tube to vertical | _____ ° |
| F: SHv seat height front | _____ cm | K: Position of the steering wheel bearing block | _____ cm |
| G: KP tipping point
(Inner side rear tube up to axis middle drive wheel) | _____ cm | L: Distance between steering wheel bearing blocks | _____ cm |
| | | M: Lower leg width top | _____ cm |
| | | N: Lower leg width bottom | _____ cm |

Note: In the case of oversized frame geometry, the seat tube is manufactured as standard from a from a seat tube angle of approx. 30° to the horizontal with a tube bend.

Dimensional tolerances according to DIN EN ISO 13920 apply for the design (dimensions in mm)

Degree of accuracy	Up to 30	More then 30 to 120	More then 120 to 400	More then 400 to 1000
C	+/- 1	+/- 3	+/- 4	+/- 6

Frame colour – one-colour design

Information about current colour designs and example images at: www.proactiv-gmbh.de/farben.php

frame colour: Selection from colour palette

Frame colour is specified when ordering

A9000100170-000

Powder coatings

White RAL 9016

gloss A9000100170-023

matt A9000100170-123 € 40.10

Brilliant silver

gloss A9000100170-011

Anthracite RAL 7016

gloss A9000100170-001

matt A9000100170-101 € 40.10

Black RAL 9005

gloss A9000100170-003

matt A9000100170-019 € 40.10

Pure orange RAL 2004

gloss A9000100170-022

matt A9000100170-122 € 40.10

Pink magenta RAL 4010

gloss A9000100170-037

matt A9000100170-137 € 40.10

Pastel blue RAL 5024

gloss A9000100170-036

matt A9000100170-136 € 40.10

Lemon green

gloss A9000100170-005

matt A9000100170-105 € 40.10

Yellow RAL 1023

gloss A9000100170-046

matt A9000100170-146 € 40.10

Red RAL 3001

gloss A9000100170-047

matt A9000100170-147 € 40.10

Lagoon blue

gloss A9000100170-052

matt A9000100170-152 € 40.10

Athletic grey

gloss A9000100170-050

matt A9000100170-150 € 40.10

Muddy grey

gloss A9000100170-051

matt A9000100170-151 € 40.10

“Dormant” powder coatings

Deep black, silver effect

gloss A9000100170-007

Sky blue

gloss A9000100170-017

Marine blue

gloss A9000100170-045

matt A9000100170-145 € 40.10

Electric green

gloss A9000100170-015

matt A9000100170-115 € 40.10

Violet

gloss A9000100170-044

Fire red

gloss A9000100170-018

matt A9000100170-118 € 40.10

Frame colour – “liquid coating” one-colour design

€ 323.20

Storm (ice blue)

gloss A9000100170-500

matt A9000100170-501

Coffee

gloss A9000100170-520

matt A9000100170-521

Prairie (rose gold)

gloss A9000100170-504

matt A9000100170-505

Pearl (mother of pearl-white)

gloss A9000100170-524

matt A9000100170-525

Berry

gloss A9000100170-526

matt A9000100170-527

Blue ocean

gloss A9000100170-522

matt A9000100170-523

Emerald (emerald green)

gloss A9000100170-514

matt A9000100170-515

Mint

gloss A9000100170-528

matt A9000100170-529

Chilli

gloss A9000100170-516

matt A9000100170-517

Frame colour – two colour designs

Note: Frames with two colour designs in the gloss level of the design colour.

Two-colour design comprising one basic colour (on the back of the frame) and one design colour (on the front of the frame) € 248.30

Please select from the following colours:

Base colour (on the rear frame)

White RAL 9016

A9000100170-200

Brilliant silver

A9000100170-201

Anthracite RAL 7016

A9000100170-202

Black RAL 9005

A9000100170-203

Pastel blue RAL 5024

A9000100170-206

Lemon green

A9000100170-207

Yellow RAL 1023

A9000100170-208

Lagoon blue

A9000100170-212

Athletic grey

A9000100170-210

Muddy grey

A9000100170-211

Design colour (on the front frame)

Black RAL 9005

gloss A9000100170-259

matt A9000100170-260

Lemon green

gloss A9000100170-250

matt A9000100170-251

Chilli

gloss A9000100170-253

matt A9000100170-254

Pure orange RAL 2004

gloss A9000100170-255

matt A9000100170-256

Coffee

gloss A9000100170-278

matt A9000100170-279

Mint

gloss A9000100170-286

matt A9000100170-287

Emerald (emerald green)

gloss A9000100170-274

matt A9000100170-275

Storm (ice blue)

gloss A9000100170-264

matt A9000100170-265

Prairie (rose gold)

gloss A9000100170-266

matt A9000100170-267

Pearl (mother of pearl-white)

gloss A9000100170-282

matt A9000100170-283

Berry

gloss A9000100170-284

matt A9000100170-285

Blue ocean

gloss A9000100170-280

matt A9000100170-281

Colour - Attachment parts

Note: If no specifications have been made, the caster fork and bearing block are mounted in black.

Drive wheel: Aluminium rim, hub and spokes

Black A9000100171-003

Caster fork and bearing block

Silver A9000100173-011

Black A9000100173-003

Attachment parts colour design according to customer desires:

Drive wheel: Aluminium rim and design inlet¹

Pure orange RAL 2004 A9000100171-022 € 193.10

White RAL 9016 A9000100171-023 € 193.10

Frame colour A9000100171-999 € 230.80

Selection of single colour coating (deviating from the frame colour) A9000100171-998 € 267.10

Colour: _____

A9000100170-

Caster wheel: 5" aluminium rim² (3-spoke design)

Pure orange RAL 2004 A9000100174-022 € 44.40

White RAL 9016 A9000100174-023 € 44.40

Frame colour A9000100174-999 € 69.50

Selection of single colour coating (deviating from the frame colour) A9000100174-998 € 80.60

Colour: _____

A9000100170-

Special colour requests (frame or attachment parts)

Frame colour individual procurement Selection from RAL colour palette

A9000100170-100 € 383.10

Degree of gloss

gloss

matt

Colour designation

RAL number

Note: Attachment parts **not** possible in design colours

¹ Only in conjunction with Liteline hub (for drive wheel aluminium rim with 18 or 36 spokes, object).

² Only in conjunction with 5" caster wheel aluminium rim 3-spoke design easy running A9000501200 or good shock absorption A9000501210

Push handles

Back tube with integrated handles

A9000401051-K € 120.60

straight

Also possible with lumbar curvature:

1 cm

2 cm

3 cm



Aluminium push handles fixed in back tube

A9000401050 € 120.60

from RH 23 cm



Push handles, horizontally screwed in back tube

A9000401076 € 223.60

can be unscrewed



Safety push handles with continuous height adjustment

A9000401060 € 200.10

from RH 30 cm with adaptable back

from RH 43 cm with back shell

Starting at a back height of 35 cm for back

tube with lordosis support



Safety push handles back-positioned length 45 cm

A9000401075 € 344.80

continuous height adjustment,

Safety push handle holder mounted on the back cross bar

Up to a SB of 42 cm or a body weight of 95 kg

Cannot be swivelled in conjunction with armrest



Backrest

Aluminium side guard, contour following the wheel

A9015402470-002

Backrest screwed, not foldable, back angle 90° to the floor

Adapted to the upper edge of the tyre



Aluminium side guard, contour by indicated dimension

A9015402470-001 € 155.00

Bolted backrest, cannot be folded

Indicated dimension:

A = __ cm / B = __ cm

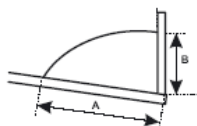

Aluminium side guard, with bolted clothing guard

A9015400025 € 334.00

Bolted backrest, cannot be folded

Wheel cover runs parallel to the contour to the drive wheel tyres at a

Distance of approx. 8 to 12 mm



Aluminium side guard, with integrated clothing guard

A9015400026 € 607.30

Clothing guard and side panel in one piece, individually manufactured, coated in frame colour. Permanently bolted backrest, cannot be folded,

Wheel cover runs parallel to the contour to the drive wheel tyres at a Distance of approx. 8 to 12 mm



Carbon side panel, with integrated clothing guard

A9015400028 € 836.10

Clothing guard and side panel in one piece, individually manufactured.

Permanently bolted backrest, cannot be folded, backrest angle 90° to the floor, wheel cover runs contour-parallel to the drive wheel tyres at a distance of approx.

8 - 12 mm



Folding backrest

A9000400011
7-way angle adjustment,
with integrated plastic coated
Aluminium side sections



Back tube with lumbar curvature

- A9000400005-K € 105.80
- 1 cm
- 2 cm
- 3 cm



Back equipment

Adaptable back with back padding

A9000802010-K
Cover: Black, breathable, open surface
Equipment with back cross bar



Equipment without back upholstery and without back padding or back system

A9000802011 € - 53.00
Equipment with back cross bar

Other back systems, such as ergonomic back shell etc. see
separate order sheet: "PRO ACTIV seat and back systems"



Seat upholstery

Body Contour

A9000801025-K
Approved up to a body weight of 120 kg

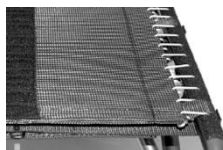

Open belt system

A9000801010-K € 71.10

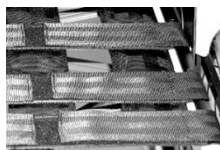

Equipment without seat upholstery

A9000801050



Seat cushion

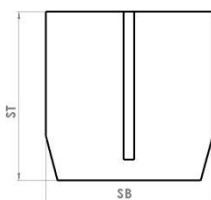

Seat cushion for individual frame
geometry in a rectangular contour
Inlet: Standard

A9000805190-K € 149.20

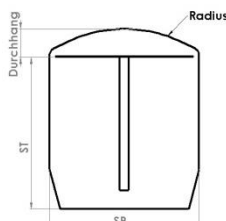

Seat cushion for individual frame
geometry with radius contour
Inlet: Standard

A9000805320-K € 190.60

Seat cushion height:

- 3 cm 5 cm
- 4 cm 6 cm

Seat cushion for individual frame geometry in a rectangular contour Inlet: Anti-Decubitus <input type="checkbox"/> A9000805210-K € 445.10	Seat cushion for individual frame geometry with radius contour Inlet: Anti-Decubitus <input type="checkbox"/> A9000805310-K € 486.10	Seat cushion height: <input type="checkbox"/> 4 cm <input type="checkbox"/> 6 cm
--	---	---

Cover:

- Black, breathable, open surface
- Black, breathable, closed surface

If not specified, the cover fabric "black, breathable, open surface" is delivered.

Seat cushion is existing

Brand/type _____

Cushion height _____ cm

You can also find the seat cushions on our separate "PRO ACTIV Seat and Back Systems" order sheet

Clothing guard

Aluminium clothing guard removable via lock function

Adjustable following wheel arch
 Only in combination with folding backrest

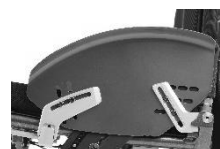

in anthracite matt

A9000403215-K € 224.90

in frame colour (basic colour with two-colour design)

A9000403216-K € 287.60

in design colour (only possible with frame in two-colour design)

A9000403217-K € 319.00

Carbon clothing guard removable via lock function

A9000400013-K € 521.20

Adjustable following wheel arch
 Only in combination with folding backrest



Wheelbase extension

Wheelbase extension, angle-adjustable and removable

A9015100005 € 677.30

with continuous axle tube, height adjustment via gear joint adjustable in 6° angular increments wheel position displacement approx. 14 cm 4°/6° camber integrated, adjustable track Attachment possibility must be checked by PRO ACTIV. Only in combination with base plate. Up to 120 kg load capacity.



Wheelbase extension permanently welded

A9015100002 € 584.00

with second axle tube, 1°/ 4° or 6° camber integrated, distance between axle tubes 150 mm as standard, other distances according to drawing set Track can be adjusted independently Version must be checked by PRO ACTIV Only possible without base plate

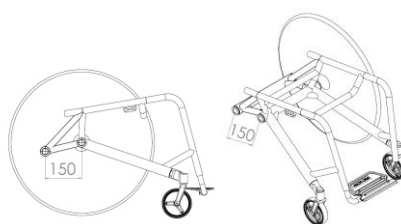

Wheel camber

*Total width with tight-mounted handrim

1° drive wheel camber

A9016202010
 Total width = approx. SB + 20 cm*

4° drive wheel camber

A9016202030
 Total width = approx. SB + 26 cm*

6° drive wheel camber

A9016202040
 Total width = approx. SB + 30 cm*

Brake system

Integral parking brake positioned on lower frame tube

A9015705001 € 496.10



Integral parking brake positioned on upper frame tube

A9015705000-K € 489.90

Please note:

In order to maintain the function of the foldable backrest, the plastic-coated side part version is mounted "-5", guided low by the contour, thus preventing collision with the integral brake when the backrest is folded down.



Brake system push to lock Standard brake handle

A9000701010-001



Brake system push to lock Long brake lever

A9000701010-002



Brake system push to lock Low brake handle

A9000701010-003



Brake lever at 20°

A9000700002

Only in conjunction with knee lever brake system, standard brake lever, long or low.



Brake system push to lock Brake handle to flip-down

A9000706008 € 146.70

Length: 9 cm



Brake system push to lock with cable pull operation

A9000700001 € 319.70

Brake mounted on the bottom frame tube. Operation via Bowden cable, operating handle mounted on the seat tube in the area of the frame bend

Attachment possibility must be checked by PRO ACTIV individually



Footrest

Continuous footrest

A9016601010-K*
with tubular resting bracket
height adjustable +/- 3 cm
For equipment of the footrest with "Rubber coated footplate support", please select under "Footrest accessories"



Footbar folds up to the rear with spring locking mechanism

A9016602005-K* € 265.70

with continuous tubular resting bracket from USL approx. 36 cm, depending on the individual frame height, tested by PRO ACTIV.

For equipment of the footrest with "Rubber coated footplate support", please select under "Footrest accessories"



Footrest folding back to the rear

A9016602010-K* € 284.70

with continuous tubular resting bracket and 20 mm operating lever
For equipment of the footrest with "Rubber coated footplate support", please select under "Footrest accessories"



Footrest accessories

Rubber coated footplate

A9000610000-K € 116.40

bolted, angle-adjustable
Depth: 14 cm



Footplate side stop

A9000610100 € 55.20

adjustable
only in combination with rubber coated
footplate



Adaptations

Anti-tipping support

right side A9000300100-K003 € 173.70

left side A9000300100-K004 € 173.70

pivotable,
screwed to the welded base plate with tension
spring
Not in combination with other removable
wheelbase extension.



Transit wheels

A9000301100 € 304.80

with universal adapter, removable
not in combination with anti-tipping support



Tilting clamp

right side A9000302101-001 € 129.50

left side A9000302101-002 € 129.50

with universal adapter and Quick pin
not in combination with anti-tipping support,
right side or left side

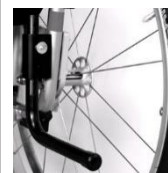

4 Dance central anti-tipping support

A9000300010 € 478.40

removable via quick release lever with rotating
caster fork and skate wheel
Ø 80 mm
adjustable ground clearance and angle
Colour: black



3" caster wheel

3" Skate wheel (80 mm)

A9000501110 € 65.40

puncture-proof



4" caster wheel

4" caster wheel "Standard" solid rubber black

A9000501011-004
(82A), puncture-proof



4" Skate wheel (100 mm)

A9000501120
puncture-proof

€ 65.40



4" safety light-up wheel (100 mm)

A9000501220
puncture-proof

€ 87.60



4" Frog Legs caster wheel (100 mm)

A9000501230 € 196.50
with replaceable rubber 6 mm, puncture-proof
Colour: black, silver rim
Incl. hair guard spacer (5.3 mm)



5" caster wheel

5" caster wheel "Standard" PU black

A9000501036-005
(82A), puncture-proof



5" Caster wheel "Standard" PU grey

A9000501031-005
(82A), puncture-proof



5" Caster wheel "2 components"

A9000501030
puncture-proof

€ 52.00



5" safety light-up wheel (125 mm)

A9000501221 € 87.60
puncture-proof



5" Aluminium rim 3-spoke design "easy running"

Silver, anodised
A9000501200

€ 160.50

black
A9000501201

€ 160.50

with exchangeable rubber ring 3 mm,
hard, puncture-proof
Incl. hair guard spacer (3 mm)



5" aluminium rim 3-spoke design "Good shock absorption"

Silver, anodised
A9000501210

€ 166.30

black
A9000501211

€ 166.30

with replaceable rubber 6 mm, medium hard,
puncture-proof
Incl. hair guard spacer (3 mm)



5" Frog Legs caster wheel (125 mm)

A9000501232 € 196.50
with replaceable rubber 6 mm, puncture-proof
Colour: black, silver rim
Incl. hair guard spacer (5.3 mm)



6" caster wheel

6" Caster wheel "Standard" PU grey

A9000501010-006
(82A), puncture-proof



6" caster wheel "pneumatic tyre"

A9000501050 € 52.90



6" caster wheel "Flexel System"

A9000501070 € 52.90
puncture-proof



Caster fork

Caster fork colours, see "Component colours"

Caster fork Standard

A9000500100-K001
with screwed axle

A9000500100-K002 € 154.80
with quick-release axle



Caster fork, short

A9000500110-K001
with screwed axle

A9000500110-K002 € 154.80
with quick-release axle



Heavy duty caster fork

For high loads or
when using additional electric drives

A9000510111-K001 € 49.90
with screwed axle

A9000510111-K002 € 202.40
with quick-release axle



Heavy duty caster fork short for high loads

A9000510120-K001 € 49.90
with screwed axle

A9000510120-K002 € 202.40
with quick-release axle

Suspension fork

incl. 5" aluminium rim "good shock absorption"

A9000500160-K001 € 466.90
with screwed axle

A9000500160-K002 € 570.40
with quick-release axle



Caster fork spare wheel "Standard"

A9000500300-K € 274.40
Standard caster forks with quick-release axles



Caster fork spare wheel "Heavy Duty"

A9000500301-K € 312.50
Heavy duty caster forks with quick-release
axles



The spare caster fork does not have a caster wheel.
In case a caster wheel is requested, please
put a cross on a second selection in the
category "Caster wheels".

Drive wheels

Drive wheel, 18 spoke aluminium rim

24" (ETRTO 540)
A9000203122

with Liteline hub, spoked radially
Not in combination with:

- Puncture-proof tyres
- One-hand drive
- Adaptive bike

only up to a body weight of 70 kg:

Sturz \ Gewicht	1°	4°	6°	8°	10°
bis 50 Kg	✓	✓	✓	✓	✓
51 - 60 Kg	✓	✓	✓	✓	
61 - 70 Kg	✓	✓			



Drive wheel, 36 spoke aluminium rim

24" (ETRTO 540)
A9000203000

Up to 120 kg body weight with Liteline hub
(left image)

Over 120 kg body weight with aluminium high
flange (right image)
radially spoked



Drive wheel double rim 36 spokes

24" (ETRTO 540)
A9000203100 € 145.90

25" (ETRTO 559)
A9000203200 € 145.90

26" (ETRTO 590)
A9000203300 € 145.90

with aluminium front hub,
radially spoked
Use with higher loads and body weight
> 120 kg



Spinergy running wheel "Spox Sport" with 24 PBO spokes; rim, hub and spokes in black

24" (ETRTO 540) € 725.00
A9000203550

25" (ETRTO 559) € 725.00
A9000201559

26" (ETRTO 590) € 725.00
A9000203555



Spinergy "Everyday Light Extreme" with 12 PBO spokes; rim and hub in black, spokes white

24" (ETRTO 540) € 885.00
A9000203554



Spinergy "Everyday Light Extreme" with 12 PBO spokes; rim, hub and spokes in black

24" (ETRTO 540) € 885.00
A9000203552



Handrims

x = dimension handrim attachment

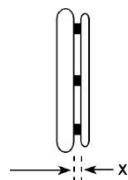

Handrim attachment

General:

x = 11 mm

x = 19 mm

Handrim attachment

Curve handrim:

x = 10 mm

x = 18 mm

Unless otherwise specified, the handrim is mounted wide (19 mm/18 mm)

Stainless steel Ø 20 mm

24" handrim for
24" wheel and
25" wheel
A9000205010-004

26" handrim for
26" wheel
A9000205010-006



Aluminium Ø 19 mm silver anodised

24" handrim for
24" wheel and
25" wheel
A9000205019-004



Aluminium Ø 19 mm powder coated in frame colour

(basic colour with two-colour design)

= Gloss surface

= Matt surface

Note: Matt coating is not recommended due to the low grip.

24" handrim for
24" wheel and
25" wheel
A9000205020-004 **€ 63.10**

26" handrim for
26" wheel
A9000205020-006 **€ 63.10**



Aluminium Ø 19 mm polished and hard-anodised

24" handrim for
24" wheel and
25" wheel **€ 152.50**
A9000205030-004

26" handrim for
26" wheel **€ 152.50**
A9000205030-006

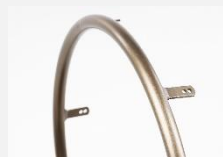

Titanium Ø 19 mm

Handrim for
24" wheel and
25" wheel **€ 310.30**
A9000205040-004

26" handrim for
26" wheel **€ 310.30**
A9000205040-006









Silicone handrim cover

for 24" handrim **€ 215.20**
A9000205100-004

for 26" handrim **€ 215.20**
A9000205100-006

Surface without structure,
compatible with handrim Ø 19 mm or
Ø 20 mm.



<p>Ultra-Grip “very grippy”</p> <p><input type="checkbox"/> 24" handrim for 24" wheel and 25" wheel A9000205070-004 € 372.10</p> <p><input type="checkbox"/> 26" handrim for 26" wheel A9000205070-006 € 372.10</p> 	<p>Ergo-Grip</p> <p><input type="checkbox"/> 24" handrim for 24" wheel and 25" wheel A9000205080-004 € 377.90</p> <p><input type="checkbox"/> 26" handrim for 26" wheel A9000205080-006 € 377.90 Attachment fitting to the rim</p> 	<p>Curve black anodised, ergonomic handrim profile</p> <p><input type="checkbox"/> 24" handrim for 24" wheel and 25" wheel H 24 mm A9000205130-004 € 370.60</p> <p><input type="checkbox"/> 24" handrim for 24" wheel and 25" wheel H 31 mm, size L A9000205140-004 € 370.60</p> <p><input type="checkbox"/> 26" handrim for 26" wheel H 31 mm, size L A9000205140-006 € 370.60</p> 
<p>Curve silver anodised ergonomic handrim profile</p> <p><input type="checkbox"/> 24" handrim for 24" wheel and 25" wheel H 31 mm, size L A9000205160-004 € 375.50</p> 	<p>Curve powder-coated, ergonomic handrim profile</p> <p><input type="checkbox"/> = Frame colour (gloss surface) <input type="checkbox"/> = black (gloss surface)</p> <p>Note: Matt coating is not recommended due to the low grip.</p> <p><input type="checkbox"/> 24" handrim for 24" wheel and 25" wheel H 24 mm A9000205135-004 € 432.40</p> <p><input type="checkbox"/> 24" handrim for 24" wheel and 25" wheel H 31 mm, size L A9000205145-004 € 432.40</p> <p><input type="checkbox"/> 26" handrim for 26" wheel H 31 mm, size L A9000205145-006 € 432.40</p>  <p>Profilhöhe H: 24mm oder 31mm</p>	<p>Curve Grip, with Tetra-Grip coating, ergonomic handrim profile</p> <p><input type="checkbox"/> 24" handrim for 24" wheel and 25" wheel H 31 mm size L A9000205150-004 € 481.40</p> 

<p>Quadro with Tetra-Grip coating</p> <p><input type="checkbox"/> 24" handrim for 24" wheel and 25" wheel A9000205170-004 € 492.90</p> <p><input type="checkbox"/> 25" handrim for 25" wheel A9000205170-005 € 492.90</p> <p><input type="checkbox"/> 26" handrim for 26" wheel A9000205170-006 € 492.90</p> 	<p>Gekko black anodised</p> <p><input type="checkbox"/> 24" handrim for 24" wheel and 25" wheel A9000205175-004 € 477.30</p> <p><input type="checkbox"/> 25" handrim for 25" wheel A9000205175-005 € 477.30</p> <p><input type="checkbox"/> 26" handrim for 26" wheel A9000205175-006 € 477.30</p> <p>with a robust and replaceable silicone lip, fully integrated into the profile Profile height 31 mm</p> 	<p>Gekko silver anodised</p> <p><input type="checkbox"/> 24" handrim for 24" wheel and 25" wheel A9000205185-004 € 488.80</p> <p>with a robust and replaceable silicone lip, fully integrated into the profile Profile height 31 mm</p> 
<p>Gekko S black anodised</p> <p><input type="checkbox"/> 24" handrim for 24" wheel and 25" wheel A9000205195-004 € 477.30</p> <p>with a robust and replaceable silicone lip, fully integrated into the profile Profile height 24 mm</p> 	<p>Equipment without handrims</p> <p><input checked="" type="checkbox"/> A9000205990</p>	
<p>Spoke guard</p>		
<p>Finger- and spoke guard "transparent"</p> <p><input type="checkbox"/> for 24" wheel A9000206300-004 € 191.50</p> <p><input type="checkbox"/> for 26" wheel A9000206300-006 € 191.50</p> 		

Tyres

Schwalbe "RightRun" High-pressure tyre

- 24x1" (540-25)
A9000204001-004
Colour: black
7.5 bar



Schwalbe "RightRun" High-pressure tyre

- 24x1" (540-25)
A9000204000-004
- 25x1" (559-23)
A9000204000-005
- 26x1" (590-25)
A9000204000-006
Colour: Grey, black wall
7.5 bar



Schwalbe "DownTown" Profiled tyres

- 24x1" (540-25)
A9000204010-004
7.5 bar



Schwalbe "MarathonPlus Evolution" with "smart guard" puncture protection

- 24x1" (540-25) € 45.50
A9000204030-014
- 25x1" (559-25) € 45.50
A9000204030-015
- 26x1" (590-25) € 45.50
A9000204030-016
Colour: black
10 bar



Schwalbe "MarathonPlus" with "smart guard" puncture protection

- 24x1" (540-25) € 45.50
A9000204030-004
Colour: Grey, black wall
10 bar



Schwalbe "One"

- 24x1" (540-25) € 86.00
A9000204123-004
Colour: black
9 bar



Puncture-proof tyre "solid rubber tyres"

- 24x1" (540-25) € 113.40
A9000204201-004
Colour: black
Not in combination with the 18 spoke drive
wheel, Spinergy and one-hand drive



Accessories

24" MTB spare wheel set









with double rim (ETRTO 507), aluminium front hub, quick-release axle and stainless steel handrim
Mountain bike tyres, selectively:

- A9000203410 € 650.40
24x1.75" Schwalbe "Marathon Plus"
Brake setting compatible with 24x1" wheel



- A9000203413 € 650.40
24x2.1" Schwalbe "SMART SAM Sport"
Brake setting not compatible with 24x1" wheel



<p>Through axle with assistance, Large push button</p> <p><input type="checkbox"/> A9000200096 € 97.80</p> <p>Interlock dimension: 122 / 110 mm Axle diameter: 12 mm Not in conjunction with lockable drive wheel axle clip "Tetra Clip", Not in combination with one-hand drive</p> 	<p>Lockable drive wheel axle clip "Tetra Clip"</p> <p><input type="checkbox"/> A9000206400 € 153.90</p> <p>Not for Spinergy drive wheels, one-hand drive brake or Liteline hub.</p> 	<p>Hand air compressor with pressure gauge</p> <p><input type="checkbox"/> A9000901100 € 98.30</p> <p>up to 14 bar</p> 
<p>Length-adjustable safety belt with buckle</p> <p><input type="checkbox"/> A9000902100 € 74.60</p> 	<p>Adjustable safety belt with hook and fastener</p> <p><input type="checkbox"/> A9000902110 € 59.60</p> 	<p>Crutch holder with nylon cup</p> <p><input type="checkbox"/> A9000902310 € 127.00</p> <p>flexible</p> 
<p>SIGMA lighting set</p> <p><input type="checkbox"/> A9000903270 € 99.80</p> <p>Consisting of front light and rear lights, chargeable via Micro USB socket, incl. Micro USB charging cable. Lighting set compliant with road traffic regulations</p> 	<p>Transport bag for drive wheels</p> <p><input type="checkbox"/> for 24" wheel A9000903530-004 € 71.90 Ø 76 cm x 2 cm</p> <p><input type="checkbox"/> for 26" wheel A9000903530-006 € 71.90 Ø 83 cm x 2 cm</p> 	<p>Accessory bag</p> <p><input type="checkbox"/> A9000903600 € 70.30</p> <p>17 cm x 13cm x 5 cm</p> 
<p>Further accessories, e.g., adaptive bikes, steering attachments, etc. see separate order sheet or www.proactiv-gmbh.com</p>		

Notes and remarks:

Location, Date

Signature End customer/dealer

The signature field is intended for the consultant and insured person. This confirms that the intended equipment is intended for the insured person.

- 17 - 2023-02-16 / The prices are plus statutory value-added tax and shipping costs = Included in the basic price = Position selected

Order sheet SPEEDY F2 Rev. 05 UK